



Operating & Maintenance Manual

Compressor Models

VHP300, HP375, XP375, P425 WIR

CODE: A & B



This manual contains important safety information.

Do not destroy this manual.

This manual must be available to the personnel who operate and maintain this machine.



P.O. Box 868 - 501 Sanford Ave
Mocksville, N.C. 27028

Book 22442578 (1/07)
Revised (09-12)

Doosan purchased Bobcat Company from Ingersoll-Rand Company in 2007. Any reference to Ingersoll-Rand Company or use of trademarks, service marks, logos, or other proprietary identifying marks belonging to Ingersoll-Rand Company in this manual is historical or nominative in nature, and is not meant to suggest a current affiliation between Ingersoll-Rand Company and Doosan Company or the products of either.

QUALITY POLICY

We will supply products and services that consistently meet the requirements of our customers and each other.

**CALIFORNIA
Proposition 65 Warning**

Diesel engine exhaust and some of its constituents are known to the State of California to cause cancer, birth defects, and other reproductive harm.

TABLE OF CONTENTS
Operating & Maintenance Manual

TITLE	PAGE
FOREWORD	9
Foreword	10
WARRANTY	13
Warranty	14
General Warranty Information.....	16
Extended Limited Airend Warranty.....	18
Warranty Registration.....	19
Complete Machine Registration.....	19
Engine Registration:.....	19
DECALS	21
DECALS	22
NOISE EMISSION	31
NOISE EMISSION CONTROL MAINTENANCE LOG	32
Noise Emission Warranty.....	32
Introduction.....	33
Maintenance Schedule.....	33
A. Compressed Air Leaks.....	33
B. Safety and Control Systems.....	33
C. Acoustic Materials.....	33
D. Fasteners.....	34
E. Enclosure Panels.....	34
F. Air Intake and Engine Exhaust.....	34
G. Cooling Systems.....	34
H. Isolation Mounts.....	34
I. Engine Operation.....	34
J. Fuels and Lubricants.....	34
SAFETY	37
Safety	38
General Information.....	38
Compressed Air.....	39
Materials.....	40
Battery.....	40
Radiator.....	40
Transport.....	41
Safety Chains/Connections and Their Adjustment.....	41

TABLE OF CONTENTS

Operating & Maintenance Manual

TITLE	PAGE
GENERAL ARRANGEMENT	43
General Arrangement	44
Compressor	46
Lubricating Oil Specification	48
Engine	49
Commissioning	49
 OPERATING INSTRUCTIONS	 51
Operating Instructions	52
Prior to Starting	52
Control Panel	54
Diagnostic/Auto Shutdown (Standard)	54
.....	56
Starting the Machine	61
Push After Warm Up	62
Dual Pressure when Fitted	62
Stopping the Machine	62
Emergency Stopping	62
Re-Starting After an Emergency	63
Monitoring During Operation	63
Decommissioning	63
Engine	64
Engine Serial Number Plate	64
Fuels, Lubricants and Coolant	64
Diesel Fuel	64
Required Fuel Properties	64
Sulfur Content:	64
Bio-Diesel Fuel	65
Handling and Storing Bio-Diesel Fuel	65
Diesel Fuel Storage	66
Minimizing the Effect of Cold Weather on Diesel Engines	66
Diesel Engine Oil	67
Diesel Engine Coolant	67
Supplemental Coolant Additives	68
Coolant Drain Intervals	68
Operating in Warm Temperature Climates	69
 LUBRICATION	 71
Lubrication	72
Lubrication and Maintenance Service Interval Chart	72
Lubrication & Maintenance/Daily	73
Daily Pre-starting Checks	73
Changing Engine Oil and Replacing Filter	73
To change engine oil and oil filter:	74
Cleaning Crankcase Vent Tube	75
Replacing Fuel Filter Elements	75
Checking Belt Tensioner Spring Tension and Belt Wear (Automatic Tensioner)	76
Checking Belt Wear	76

TABLE OF CONTENTS

Operating & Maintenance Manual

TITLE	PAGE
Checking Tensioner Spring Tension	76
Checking Engine Electrical Ground Connections	77
Replenishing Supplemental Coolant Additives (SCAs) Between Coolant Changes	77
Replacing Fan and Alternator Belts	78
Bleeding the Fuel System	78
At Fuel Injection Pump	79
At Fuel Injection Nozzles	79
Do Not Modify Fuel System	79
Troubleshooting	80
General Troubleshooting Information	80
Precautions for Welding on Engines Equipped with Electronic Engine Control Unit (ECU)	80
Displaying of Diagnostic Trouble Codes (DTCs)	86
Intermittent Fault Diagnostics (With Electronic Controls)	86
Suggestions for diagnosing intermittent faults:	86
Possible causes of intermittent faults:	87
Storage	87
Engine Storage Guidelines	87
Preparing Engine for Long Term Storage	87
Removing Engine from Long Term Storage	88
Specifications	89
Engine Crankcase Oil Fill Quantities	90
Lubrication and Maintenance Records	90
Using Lubrication and Maintenance Records	90
Emission System Warranty	90
Emissions Control System Certification Label	91

TABLE OF CONTENTS

Operating & Maintenance Manual

TITLE	PAGE
MAINTENANCE	93
Maintenance	94
Routine Maintenance	99
Productive Shutdown System	101
Scavenge Line	101
Compressor Oil Filter	102
Compressor Oil Separator Element	103
Compressor Oil Cooler and Engine Radiator	104
Air Filter Elements	105
Ventilation	105
Cooling Fan Drive	105
Fuel System	106
Fuel Filter Water Separator	106
Charge Air Cooler Pipework	106
Hoses	106
Electrical System	106
Battery	107
Pressure System	107
Tyres/Tyre/Tire Pressure	107
Running Gear/Wheels	107
Lubrication	108
Engine Lubricating Oil	108
Engine Lubricating Oil Specification	108
Engine Oil Filter Element	108
Compressor Lubricating Oil	108
Compressor Oil Filter Element	109
Running Gear Wheel Bearings	109
Speed and Pressure Regulation Adjustment	110
MACHINE SYSTEMS	115
Machine Systems	116
Wedge to Engine Interface - IR Engine	117
Harness System Schematic	118
J1939 CAN Communications Schematic	118
SERVICE TOOLS	119
Service Tools	120
Electronic Systems	120
Service Tools	122
Electrical Parts	124
FAULT FINDING	125
Fault Finding	126

TABLE OF CONTENTS
Operating & Maintenance Manual

TITLE	PAGE
OPTIONS	131
Options - Lubricator	132
Safety	132
General Information	132
Operating Instructions	133
Commissioning	133
Prior to Starting	133
Maintenance	133
Fault Finding	133

*****Always use Ingersoll-Rand Replacement parts!*****



Foreword



Foreword

The contents of this manual are considered to be proprietary and confidential to Ingersoll-Rand and should not be reproduced without the prior written permission of Ingersoll-Rand.

Nothing contained in this document is intended to extend any promise, warranty or representation, expressed or implied, regarding the Ingersoll-Rand products described herein. Any such warranties or other terms and conditions of sale of products shall be in accordance with the standard terms and conditions of sale for such products, which are available upon request.

This manual contains instructions and technical data to cover all routine operation and scheduled maintenance tasks by operation and maintenance staff. Major overhauls are outside the scope of this manual and should be referred to authorised Ingersoll-Rand service department.

The design specification of this machine has been certified as complying with EC directives. As a result:

- a. Any machine modifications are strictly prohibited, and will invalidate EC certification.
- b. A unique specification for USA/Canada is adopted and tailored to the territory.

All components, accessories, pipes and connectors added to the compressed air system should be:

- of good quality, procured from a reputable manufacturer and, wherever possible, be of a type approved by Ingersoll–Rand.
- clearly rated for a pressure at least equal to the machine maximum allowable working pressure.
- compatible with the compressor lubricant/coolant.
- accompanied with instructions for safe installation, operation and maintenance.

Details of approved equipment are available from Ingersoll–Rand Service departments.

The use of repair parts/lubricants/fluids other than those included within the Ingersoll–Rand approved parts list may create hazardous conditions over which Ingersoll–Rand has no control. Therefore Ingersoll–Rand cannot be held responsible for equipment in which non–approved repair parts are installed.

Ingersoll–Rand reserves the right to make changes and improvements to products without notice and without incurring any obligation to make such changes or add such improvements to products sold previously.

The intended uses of this machine are outlined below and examples of unapproved usage are also given, however Ingersoll–Rand cannot anticipate every application or work situation that may arise.

IF IN DOUBT CONSULT SUPERVISION.

This machine has been designed and supplied for use only in the following specified conditions and applications:

- Compression of normal ambient air containing no known or detectable additional gases, vapours or particles.
- Operation within the ambient temperature range specified in the *GENERAL INFORMATION* section of this manual.

UNITS MANUFACTURED IN NORTH AMERICA: Generation of electricity at 120V (1ph) at 60 Hertz.

UNITS MANUFACTURED IN EUROPE: Generation of electricity not applicable.

The use of the machine in any of the situation types listed in table 1:-

- a) Is not approved by Ingersoll–Rand,**
- b) May impair the safety of users and other persons, and**
- c) May prejudice any claims made against Ingersoll–Rand.**

TABLE 1
Use of the machine to produce compressed air for: a) direct human consumption b) indirect human consumption, without suitable filtration and purity checks.
Use of the machine outside the ambient temperature range specified in the <i>GENERAL INFORMATION SECTION</i> of this manual.
This machine is not intended and must not be used in potentially explosive atmospheres, including situations where flammable gases or vapours may be present.
Use of the machine fitted with non Ingersoll–Rand approved components/lubricants/ fluids.
Use of the machine with safety or control components missing or disabled.
Use of the machine for storage or transportation of materials inside or on the enclosure except when contained within the toolbox.
GENERATOR
Use of the generator to supply load(s) greater than those specified.
Use of unsafe or unserviceable electrical equipment connected to the generator.
Use of electrical equipment: (a) Having incorrect voltage and/or frequency ratings. (b) Containing computer equipment and/or similar electronics.

The company accepts no responsibility for errors in translation of this manual from the original English version.

*****Always use Ingersoll-Rand Replacement parts!*****



Warranty



Warranty

Ingersoll-Rand, through its distributor, warrants that each item of equipment manufactured by it and delivered hereunder to the initial user will be free of defects in material and workmanship.

With respect to the following types of equipment, the warranty period enumerated below will apply.

- A. **Aftercoolers** - The earlier of nine (9) months from date of shipment to or six (6) months from start up by initial user.
- B. **Portable Compressors, Portable Generator Sets (GENSET), Portable Light Towers and Air Dyers** - The earlier of twelve (12) months from shipment to or the accumulation of 2,000 hours of service by the initial user.
- C. **Portable Compressor Air Ends** - The earlier of twenty-four (24) months from shipment to or the accumulation of 4,000 hours of service by the initial user. For Air ends, the warranty against defects will include replacement of the complete Air End, provided the original Air End, is returned assembled and unopened.

Portable Compressor Airend Limited Optional Warranty - The earlier of sixty (60) months from shipment to or the accumulation of 10,000 hours of service. The optional warranty is limited to defects in rotors, housings, bearings and gears and provided all the following conditions are met:

The original airend is returned assembled and unopened.

Continued use of genuine Ingersoll-Rand parts, fluids, oils and filters.

Maintenance is performed at prescribed intervals.

- D. **Genset Generators** - The earlier of twenty-four (24) months from shipment to or the accumulation of 4,000 hours of service by the initial user.
- E. **Portable Light Tower Generators** - The earlier of twelve (12) months from shipment to or the accumulation of 2,000 hours of service by the initial user. Light Source model only, the earlier of twenty-four (24) months from shipment to or the accumulation of 4,000 hours of service.
- F. **Ingersoll-Rand Engines** - The earlier of twenty-four (24) months from shipment to or the accumulation of 4,000 hours of service.
- G. **Ingersoll-Rand Platinum Drive Train Warranty (Optional)** - Platinum drive train pertains to the Ingersoll-Rand Engine and Airend combination. The earlier of sixty (60) months from shipment to, or the accumulation of 10,000 hours of service. The starter, alternator, fuel injection system and all electrical components are excluded from the extended warranty. The airend seal and drive coupling are included in the warranty (air-end drive belts are not included). The optional warranty is automatically available when meeting the following conditions:

The original airend is returned assembled and unopened.

Continued use of genuine Ingersoll-Rand parts, fluids, oils and filters.

Maintenance is performed at prescribed intervals.

It is the obligation of the user to provide verification that these conditions have been satisfied when submitting warranty claims.

H. Spare Parts - Six (6) months from date of installation

Ingersoll-Rand will provide a new part or repaired part, at its election, in place of any part which is found upon its inspection to be defective in material and workmanship during the period prescribed above. Such part will be repaired or replaced without charge to the initial user during normal working hours at the place of business of an Ingersoll-Rand distributor authorized to sell the type of equipment involved or other establishment authorized by Ingersoll-Rand. User must present proof of purchase at the time of exercising warranty.

The above warranty does not apply to failures occurring as a result of abuse; misuse, negligent repairs, corrosion, erosion and normal wear and tear, alterations or modifications made to the product without express written consent of Ingersoll-Rand; or failure to follow the recommended operating practices and maintenance procedures as provided in the product's operating and maintenance publications.

Accessories or equipment furnished by Ingersoll-Rand, but manufactured by others, including, but not limited to, engines, shall carry whatever warranty the manufacturers have conveyed to Ingersoll-Rand and which can be passed on to the initial user.

THIS WARRANTY IS IN LIEU OF ALL OTHER WARRANTIES EXPRESSED OR IMPLIED, (EXCEPT THAT OF TITLE) AND THERE ARE NO WARRANTIES OF MERCHANTABILITY OR OF FITNESS FOR A PARTICULAR PURPOSE.

General Warranty Information

GENERAL WARRANTY			Extended Coverage
Portable Compressor	Package	1 yr/2000 Hours	
	Airend	2 yrs/4000 Hours	5 yrs/10,000 Hours Limited Warranty, major components (refer to operator's manual).
Portable Genset 8KW, 11KW, 20 KVA thru 575KVA	Package	1 yr/2000 Hours	None
	Generator	2 yrs/4000 Hours	None
Portable Genset 3.5KW thru 7.0KW and 10KW	Package	1 yr/2000 Hours (parts only)	None
	Generator	1 yr/2000 Hours (parts only)	None
Light Tower	Package	1 yr/2000 Hours	
	Generator	1 yr/2000 Hours	2 yrs/4000 hours, for Lightsource introduced 8/16/99.

ENGINES			
	Months	Hours	Extended Coverage
CATERPILLAR	12	unlimited	Available at dealer
	24	2000	Major components 3 yrs/10,000 hrs Available at dealer
JOHN DEERE (in compressors)	24	2000	5 yrs/5000 hrs using OEM fluids and filters with \$250 deductible
(in generators as of 1/1/01)	24	2000	2 yrs/4000 hrs using IR fluids and filters
DEUTZ	24	2000	Available at dealer
INGERSOLL-RAND	24	4000	5 yrs/10,000 hrs when using genuine Ingersoll-Rand fluids and parts. Refer to operator's manual.
KUBOTA (North America only)	24	2000	Major components 36 mo/3000 hrs (parts only)
(Western Europe & Oceania)	24	2000	None
(Central & South America, Asia, Middle East & Africa)	12	1000	None
MITSUBISHI	24	2000	2 yrs/4000 Hours using IR fluids and filters
VOLVO	24	2000	2 yrs/4000 Hours using IR fluids and filters
HONDA	12	unlimited	None
VANGUARD	24	unlimited	None

PARTS			
	Months	Hours	Coverage
Ingersoll-Rand	6	No Limit	Parts Only

AIREND EXCHANGE			
	Months	Hours	Extended Coverage
Airend	12	2000	2 yrs/4000 Hours - available from IR.

NOTE: Actual warranty times may change. Consult the manufacturer's warranty policy as shipped with each new product.

Extended Limited Airend Warranty

Ingersoll-Rand Portable Compressor Division is pleased to announce the availability of extended limited airend warranty. Announcement of the extended warranty coincides with the introduction of Pro-Tec™ Compressor Fluid. Pro-Tec™ Compressor Fluid is an amber coloured fluid specially formulated for Portable Compressors and is being provided as the factory filled fluid for all machines except¹ XHP650/900/1070

All machines have the standard airend warranty - *The earlier of 24 months from shipment to, or the accumulation of 4000 hours of service by the initial user.*

The warranty against defects will include replacement of the complete Airend, provided the original airend is returned assembled and unopened.

The optional limited warranty is the earlier of 60 months from shipment to, or the accumulation of 10,000 hours of service. The optional warranty is limited to defects in major components (rotors, housings, gears and bearings), and is automatically available when the following conditions are met:

1. The original airend is returned assembled and unopened.
2. Submissions of proof that Ingersoll-Rand fluid, filters and separators have been used. Refer to the Operation and Parts manual for the correct fluids, filters and separator elements required.
3. Submissions of proof that maintenance intervals have been followed.

WARRANTY	TIME	*BARE AIREND	**AIREND COMPONENTS
STANDARD	2YRS/4,000HRS	100% PARTS & LABOUR	100% PARTS & LABOUR
OPTIONAL	5YRS/10,000HRS	100% PARTS & LABOUR	0%

*BARE AIREND - pertains to major airend parts (rotors, housings, gears and bearings).

**AIREND COMPONENTS - pertains to auxiliary attachment to the bare airend (seals, pumps, valves, tubes, hoses, fittings and filter housing).

Pro-Tec™ and XHP505 Compressor Fluids are available from your local Ingersoll-Rand branch or distributor.

For units operating within the USA & Canada, call the Mocksville Product Support Department on 1-800-633-5206

¹ XHP650/900/1070 will continue to use XHP505 and will have the extended warranty when above conditions are met.

Warranty Registration

For Units Sourced From Mocksville, USA

Complete Machine Registration

Machines shipped to locations within the United States do not require a warranty registration unless the machine status changes (i.e. change of ownership).

Machines shipped outside the United States require notification be made to initiate the machine warranty.

Fill out the Warranty Registration Form in this section, keep a copy for your records and mail form to:

Ingersoll-Rand Company
P.O. Box 868
Mocksville, North Carolina 27028
Attn: Warranty Department

NOTE: Completion of this form validates the warranty.

Engine Registration:

I-R powered machines do not require separate engine registration.

John Deere requires a separate engine registration be completed and mailed direct to John Deere.

Separate engine registration material is included with this literature package for John Deere powered machines.

All other engine manufacturers do not require a separate engine registration.

You **MUST** present proof of in-service date at time of requesting engine warranty service.

<u>Selling Distributor</u>	<u>Servicing Distributor</u>	WARRANTY REGISTRATION
Name _____	Name _____	Owner/User Name _____
Address _____	Address _____	Address _____
City _____	City _____	City _____
County _____	County _____	County _____
State _____	State _____	State _____
Zip code _____	Zip code _____	Zip code _____
Telephone _____	Telephone _____	Telephone _____

Complete the Applicable Blocks

Owner/User Type of Business (check one only)

<input type="checkbox"/> Construction-Heavy (highway, excavation, etc.)	<input type="checkbox"/> Asphalt Contractor	<input type="checkbox"/> Coal Mining	<input type="checkbox"/> Other Mining
<input type="checkbox"/> Construction-Light (carpentry, plumbing, pools, mason, etc.)	<input type="checkbox"/> Government (municipal, state, county, etc.)	<input type="checkbox"/> Quarry	<input type="checkbox"/> Shallow Oil & Gas
<input type="checkbox"/> Rental (rental center, rental fleet, etc.)	<input type="checkbox"/> Building Contractor	<input type="checkbox"/> Water well	<input type="checkbox"/> Utility Company (gas, electric, water, etc.)
<input type="checkbox"/> Industrial (plant use)	<input type="checkbox"/> Other specify _____	<input type="checkbox"/> Exploration	<input type="checkbox"/> Utility Contractor

Model S/N _____	Unit S/N _____	Engine S/N _____	Date delivered _____
Unit-Hours _____	Airend S/N _____	Truck S/N _____	Truck Engine S/N _____

SERVICING DISTRIBUTOR/USER ACKNOWLEDGEMENT

1. The Purchaser has been instructed and/or has read the manual and understands proper preventative maintenance, general operation and safety precautions.
2. The warranty and limitation of liability has been reviewed and understood by the owner/user.
3. In the event that this unit is to be used within a nuclear facility, the owner/user shall notify Ingersoll-Rand of such use so that Ingersoll-Rand may arrange for appropriate nuclear liability protection from the owner-licensee of the facility.
4. Ingersoll-Rand reserves the right to make design changes or modifications of Ingersoll-Rand products at anytime without incurring any obligation to make similar changes or modifications on previously sold units.











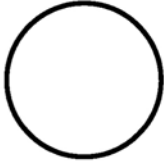

Decals



DECALS

Look for these signs on machines manufactured in Europe, which point out potential hazards to the safety of you and others. Read and understand thoroughly. Heed warnings and follow instructions. If you do not understand, inform your supervisor.

GRAPHIC FORM AND MEANING OF ISO SYMBOLS

 Prohibition / Mandatory	 Information / Instructions	 Warning
 WARNING: Electrical shock risk.	 WARNING – Pressurised component or system.	 WARNING – Hot surface.
 WARNING – Pressure control.	 WARNING – Corrosion risk.	 WARNING – Air/gas flow or Air discharge.
 WARNING – Pressurised vessel.	 WARNING – Hot and harmful exhaust gas.	 WARNING – Maintain correct tyre pressure. (Refer to the GENERAL INFORMATION section of this manual).



WARNING – Flammable liquid.



WARNING – Before connecting the tow bar or commencing to tow consult the operation and maintenance manual.

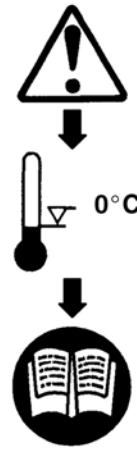

WARNING – For operating temperature below 0°C, consult the operation and maintenance manual.



WARNING – Do not undertake any maintenance on this machine until the electrical supply is disconnected and the air pressure is totally relieved.



WARNING – Consult the operation and maintenance manual before commencing any maintenance.



Do not breathe the compressed air from this machine.





















Do not remove the Operating and Maintenance manual and manual holder from this machine.



Do not stack.



Do not operate the machine without the guard being fitted.

 <p>Do not stand on any service valve or other parts of the pressure system.</p>	  <p>Do not operate with the doors or enclosure open.</p>	 <p>Do not use fork lift truck from this side.</p>
 <p>Do not exceed the trailer speed limit.</p>	 <p>No naked lights.</p>	 <p>Do not open the service valve before the airhose is attached.</p>
 <p>Use fork lift truck from this side only.</p>	 <p>Emergency stop.</p>	 <p>Tie down point</p>
 <p>Lifting point.</p>	 <p>On (power).</p>	 <p>Off (power).</p>
 <p>Read the Operation and Maintenance manual before operation or maintenance of this machine is undertaken.</p>	 <p>When parking use prop stand, handbrake and wheel chocks.</p>	 <p>Compressor oil filling</p>
 <p>Diesel fuel No open flame.</p>	 <p>Parking brake.</p>	 <p>Rough Service Designation. Wet Location Operation.</p>

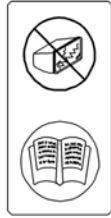

Replace any cracked protective shield.

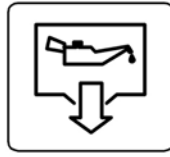

Oil drain.

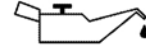

Engine Oil



Fuel level/point

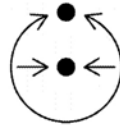

Pressure control



Malfunction

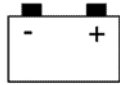

Battery charging condition

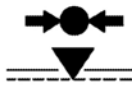

Low pressure

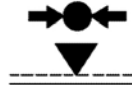

High pressure



Engine malfunction



High compressor temperature



Compressor malfunction



Low engine oil pressure

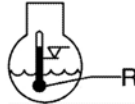

Engine high temperature

Look for these signs on machines manufactured in North America, which point out potential hazards to the safety of you and others. Read and understand thoroughly. Heed warnings and follow instructions. If you do not understand, inform your supervisor



(Red Background)

Indicates the presence of a hazard which WILL cause serious injury, death or property damage, if ignored.



(Orange Background)

Indicates the presence of a hazard which CAN cause serious injury, death or property damage, if ignored.



(Yellow Background)

Indicates the presence of a hazard which WILL or can cause injury or property damage, if ignored.



(Blue Background)

Indicates important set-up, operating or maintenance information.



⚠ WARNING

**Improper operation of this equipment.
Can cause serious injury or death.**
Read Operator's Manual supplied with this machine before operation or servicing.

**Modification or alteration of this machine.
Can cause serious injury or death.**
Do not alter or modify this machine without the express written consent of the manufacturer.



⚠ WARNING

**Collapsing jackstand.
Can cause serious injury.** 

Insert locking pin completely.

**Excessive towing speed.
Can cause serious injury or death.** 

Do NOT exceed 65 mph (105 km/hr.)



⚠ WARNING

Rotating fan blade.

Can cause serious injury. 

Do not operate without guard in place.

⚠ WARNING

Falling off machine.

Can cause serious injury or death. 

Access lifting bail from inside machine.



⚠ WARNING

Door under pressure.

Can cause serious injury.

Use both hands to open door when machine is running. 



⚠ WARNING

Disconnected air hoses whip.

Can cause serious injury or death. 

When using air tools attach safety device (OSHA Valve) at source of air supply for each tool.



CAUTION

DO NOT WELD.

ELECTRONIC DAMAGE WILL OCCUR.

This engine is equipped with an electronic engine controller and other electronic components.



⚠ WARNING

Combustible gas.

Can cause serious burns, blindness or death. 

Keep sparks and open flames away from batteries.



CAUTION

DO NOT USE ETHER.

ENGINE DAMAGE WILL OCCUR.

This engine is equipped with an electric heater starting aid.



WARNING

High pressure air. Can cause serious injury or death.



Relieve pressure before removing filler plugs/caps, fittings or covers.



USE DIESEL FUEL ONLY



NOTICE

COOLANT FILL INSTRUCTIONS

Adding:
Do NOT remove radiator cap. Top off at overflow reservoir. Use same anti-freeze mixture as in radiator.

Replacing:
With system cool, remove radiator cap. Drain coolant and close drain. At radiator, refill system. Replace radiator cap. At reservoir, fill to "Hot" level. Run for 30 minutes. Stop and allow to cool. At reservoir, add coolant as necessary to reach "Cold" level.

FREE SAFETY DECALS!

To promote communication of Safety Warnings on products manufactured by the Portable Compressor Division in Mocksville, N.C., Safety Decals are available **free** of charge. Safety decals are identified by the decal heading: **DANGER, WARNING or CAUTION.**

Decal part numbers are on the bottom of each decal and are also listed in the compressor's parts manual. Submit orders for Safety Decals to the Mocksville Parts Service Department. The no charge order should contain only Safety Decals. Help promote product safety! Assure that decals are present on the machines. Replace decals that are not readable.

This section pertains only to machines distributed within the United States.



TAMPERING WITH NOISE CONTROL SYSTEM PROHIBITED

Federal law prohibits the following acts or the causing thereof:

(1) The removal or rendering inoperative by any persons, other than for purposes of maintenance, repair, or replacement, of any device or element of design incorporated into any new compressor for the purpose of noise control prior to its sale or delivery to the ultimate purchaser or while it is in use; or (2) the use of the compressor after such device or element of design has been removed or rendered inoperative by any person.

Among those acts included in the prohibition against tampering are these:

1. Removal or rendering inoperative any of the following:
 - a. the engine exhaust system or parts thereof
 - b. the air intake system or parts thereof
 - c. enclosure or parts thereof
2. Removal of any of the following:
 - a. fan shroud
 - b. vibration mounts
 - c. sound absorption material
3. Operation of the compressor with any of the enclosure doors open.

Compressor Noise Emission Control Information

- A. The removal or rendering inoperative, other than for the purpose of maintenance, repair, or replacement of any noise control device or element of design incorporated into this compressor in compliance with the noise control act;
- B. The use of this compressor after such device or element of design has been removed or rendered inoperative.

NOTE: the above information applies only to units that are built in compliance with the U.S. Environmental Protection Agency.

Ingersoll-Rand Company reserves the right to make changes or add improvements without notice and without incurring any obligation to make such changes or add such improvements to products sold previously.

The Purchaser is urged to include the above provisions in any agreement for any resale of this compressor.

*****Always use Ingersoll-Rand Replacement parts!*****



Noise Emission



NOISE EMISSION CONTROL MAINTENANCE LOG

COMPRESSOR MODEL _____ SERIAL NO. _____ USER UNIT NO. _____
--

UNIT IDENTIFICATION ENGINE MAKE & MODEL: _____ SERIAL NO: _____ PURCHASER OR OWNER: _____ ADDRESS: _____	DEALER OR DISTRIBUTOR FROM WHOM PURCHASED: _____ _____ DATE PURCHASED: _____
---	--

The Noise Control Act of 1972 (86 Stat. 1234) prohibits tampering with the noise control system of any compressor manufactured and sold under the above regulations, specifically the following acts or the causing thereof:

- (1) The removal or rendering inoperative by any persons, other than for purposes of maintenance, repair, or replacement, of any device or element of design incorporated into any new compressor for the purpose of noise control prior to its sale or delivery to the ultimate purchaser or while it is in use; or (2) the use of the compressor after such device or element of design has been removed or rendered inoperative by any person.

Noise Emission Warranty

The manufacturer warrants to the ultimate purchaser and each subsequent purchaser that this air compressor was designed, built and equipped to conform at the time of sale to the first retail purchaser, with all applicable U.S. EPA Noise Control Regulations.

This warranty is not limited to any particular part, component, or system of the air compressor. Defects in the design, assembly or in any part, component, or system of the compressor which, at the time of sale to the first retail purchaser, caused noise emissions to exceed Federal Standards are covered by this warranty for the life of the air compressor. (40FR204.58-1).

Introduction

The unit for which this Maintenance Log is provided conforms to U.S. E.P.A. Regulations for Noise Emissions, applicable to Portable Air Compressors.

The purpose of this book is to provide (1) the Maintenance Performance Schedule below for all required noise emission controls and (2) space so that the purchaser or owner can record what maintenance was done, by whom, where and when. Detailed instructions on the maintenance items below are given on following page.

Maintenance Schedule

ITEM	AREA	PERIOD
A.	COMPRESSED AIR LEAKS	AS DETECTED
B.	SAFETY AND CONTROL SYSTEMS	AS DETECTED
C.	ACOUSTIC MATERIALS	DAILY
D.	FASTENERS	100 HOURS
E.	ENCLOSURE PANELS	100 HOURS
F.	AIR INTAKE & ENGINE EXHAUST	100 HOURS
G.	COOLING SYSTEMS	250 HOURS
H.	ISOLATION MOUNTS	250 HOURS
I.	ENGINE OPERATION	SEE OPERATOR'S MANUAL
J.	FUELS & LUBRICANTS	SEE OPERATOR'S MANUAL

A. Compressed Air Leaks

Correct all compressed air leaks during the first shutdown period after discovery. If severe enough to cause serious noise problems and efficiency loss, shut down immediately and correct the leak(s).

B. Safety and Control Systems

Repair or replace all safety and control systems or circuits as malfunction occurs. No compressor should be operated with either system bypassed, disabled, or nonfunctional.

C. Acoustic Materials

In daily inspections, observe these materials. Maintain all acoustic material as nearly as possible in its original condition. Repair or replace all sections that have: 1) sustained damage, 2) have partially separated from panels to which they were attached, 3) are missing, or have otherwise deteriorated due to severe operating or storage conditions.

D. Fasteners

All fasteners such as hinges, nuts, bolts, clamps, screws, rivets, and latches should be inspected for looseness after each 100 hours of operation. They should be retightened, repaired, or if missing, replaced immediately to prevent subsequent damage and noise emission increase.

E. Enclosure Panels

Enclosure panels should also be inspected at 100 hour operational intervals. All panels that are warped, punctured, torn, or otherwise deformed, such that their noise containment function is reduced, should be repaired or replaced before the next operation interval. Doors, access panels, and hatch closures especially, should be checked and adjusted at this time to insure continuous seating between gasket or acoustic material and the mating frame.

F. Air Intake and Engine Exhaust

Engine and compressor air intake and engine exhaust systems should be inspected after each 100 hours of operation for loose, damaged, or deteriorated components. Repairs or replacements should be made before the next period of use.

G. Cooling Systems

All components of the cooling system for engine water and compressor oil should be inspected every 250 hours of use. Any discrepancies found should be corrected before placing the unit back in operation. Unrestricted airflow over the radiator and oil cooler must be maintained at all times during operation.

H. Isolation Mounts

Engine/air end isolation mounts should be inspected after each 250 hours of operation. Those mounts with cracks or splits in the molded rubber, or with bent or broken bolts due to operation or storage in severe environments, all should be replaced with equivalent parts.

I. Engine Operation

Inspect and maintain engine condition and operation as recommended in the manuals supplied by the engine manufacturer.

J. Fuels and Lubricants

Use only the types and grades of fuels and lubricants recommended in the Ingersoll-Rand Company and Engine Manufacturer's Operator and Maintenance Manuals.

*****Always use Ingersoll-Rand Replacement parts!*****



Safety



Safety



(Red Background)

Indicates the presence of a hazard which WILL cause serious injury, death or property damage, if ignored.



(Orange Background)

Indicates the presence of a hazard which CAN cause serious injury, death or property damage, if ignored.



(Yellow Background)

Indicates the presence of a hazard which WILL or can cause injury or property damage, if ignored.



(Blue Background)

Indicates important set-up, operating or maintenance information.

General Information

Never operate unit without first observing all safety warnings and carefully reading the operation and maintenance manual shipped from the factory with this machine.

Ensure that the operator reads and *understands* the decals and consults the manuals before maintenance or operation.

Ensure that the Operation and Maintenance manual, and the manual holder, are not removed permanently from the machine.

Ensure that maintenance personnel are adequately trained, competent and have read the maintenance manuals.

Make sure that all protective covers are in place and that the canopy/doors are closed during operation.

The specification of this machine is such that the machine is not suitable for use in flammable gas risk areas. If such an application is required then all local regulations, codes of practice and site rules must be observed. To ensure that the machine can operate in a safe and reliable

manner, additional equipment such as gas detection, exhaust spark arrestors, and intake (*shut-off*) valves may be required, dependant on local regulations or the degree of risk involved.

A weekly visual check must be made on all fasteners/fixing screws securing mechanical parts. In particular, safety-related parts such as coupling hitch, drawbar components, road-wheels, and lifting bail should be checked for total security.

All components which are loose, damaged or unserviceable, must be rectified without delay.

Air discharged from this machine may contain carbon monoxide or other contaminants which will cause serious injury or death. Do not breathe this air.

This machine produces loud noise with the doors open or service valve vented. Extended exposure to loud noise can cause hearing loss. Always wear hearing protection when doors are open or service valve is vented.

Never inspect or service unit without first

disconnecting battery cable(s) to prevent accidental starting.

Do not use petroleum products (solvents or fuels) under high pressure as this can penetrate the skin and result in serious illness. Wear eye protection while cleaning until with compressed air to prevent debris from injuring eye(s).

Rotating fan blade can cause serious injury. Do not operate without guard in place.

Use care to avoid contacting hot surfaces (engine exhaust manifold and piping, air receiver and air discharge piping, etc.).

Ether is an extremely volatile, highly inflammable gas. When it is specified as a starting aid, use sparingly. **DO NOT USE ETHER IF THE MACHINE HAS GLOW PLUGS OR INLET HEATER STARTING AIDS OR ENGINE DAMAGE WILL RESULT.**

Never operate unit with guards, covers or screens removed. Keep hands, hair, clothing, tools, blow gun tips, etc. well away from moving parts.

Compressed Air

Compressed air can be dangerous if incorrectly handled. Before doing any work on the unit, ensure that all pressure is vented from the system and that the machine cannot be started accidentally.

Ensure that the machine is operating at the rated pressure and that the rated pressure is known to all relevant personnel.

All air pressure equipment installed in or connected to the machine must have safe working pressure ratings of at least the machine rated pressure.

If more than one compressor is connected to one common downstream plant, effective check valves and isolation valves must be fitted and controlled by work procedures, so that one machine cannot accidentally be pressurised/over pressurised by another.

Compressed air must not be used for a direct feed to any form of breathing apparatus or mask.

High pressure Air can cause serious injury or death. Relieve pressure before removing filler plugs/caps, fittings or covers.

Air pressure can remain trapped in air supply line which can result in serious injury or death. Always carefully vent air supply line at tool or vent valve before performing any service.

The discharged air contains a very small percentage of compressor lubricating oil and care should be taken to ensure that downstream equipment is compatible.

If the discharged air is to be ultimately released into a confined space, adequate ventilation must be provided.

When using compressed air always use appropriate personal protective equipment.

All pressure containing parts, especially flexible hoses and their couplings, must be regularly inspected, be free from defects and be replaced according to the Manual instructions.

Avoid bodily contact with compressed air.

The safety valve located in the separator tank must be checked periodically for correct operation.

Whenever the machine is stopped, air will flow back into the compressor system from devices or systems downstream of the machine unless the service valve is closed. Install a check valve at the machine service valve to prevent reverse flow in the event of an unexpected shutdown when the service valve is open.

Disconnected air hoses whip and can cause serious injury or death. Always attach a safety flow restrictor to each hose at the source of supply or branch line in accordance with OSHA Regulation 29CFR Section 1926.302(b).

Never allow the unit to sit stopped with pressure in the receiver-separator system.

Materials

The following substances *may* be produced during the operation of this machine:

- brake lining dust
- engine exhaust fumes

AVOID INHALATION

Ensure that adequate ventilation of the cooling system and exhaust gases is maintained at all times.

The following substances are used in the manufacture of this machine and *may* be hazardous to health if used incorrectly:

- anti-freeze
- compressor lubricant
- engine lubricant
- preservative grease
- rust preventative
- diesel fuel
- battery electrolyte

AVOID INGESTION, SKIN CONTACT AND INHALATION OF FUMES

Should compressor lubricant come into contact with the eyes, then irrigate with water for at least 5 minutes.

Should compressor lubricant come into contact with the skin, then wash off immediately.

Consult a physician if large amounts of compressor lubricant are ingested.

Consult a physician if compressor lubricants inhaled.

Never give fluids or induce vomiting if the patient is unconscious or having convulsions.

Safety data sheets for compressor and

engine lubricants should be obtained from the lubricant supplier.

Never operate the engine of this machine inside a building without adequate ventilation. Avoid breathing exhaust fumes when working on or near the machine.

This machine may include such materials as oil, diesel fuel, antifreeze, brake fluid, oil/air filters and batteries which may require proper disposal when performing maintenance and service tasks. Contact local authorities for proper disposal of these materials.

Battery

A battery contains sulphuric acid and can give off gases which are corrosive and potentially explosive. Avoid contact with skin, eyes and clothing. In case of contact, flush area immediately with water.

DO NOT ATTEMPT TO SLAVE START A FROZEN BATTERY SINCE THIS MAY CAUSE IT TO EXPLODE.

Exercise extreme caution when using booster battery. To jump battery, connect ends of one booster cable to the positive (+) terminal of each battery. Connect one end of other cable to the negative (-) terminal of the booster battery and other end to a ground connection away from dead battery (to avoid a spark occurring near any explosive gases that may be present). After starting unit, always disconnect cables in reverse order.

Radiator

Hot engine coolant and steam can cause injury. Ensure that the radiator filler cap is removed with due care and attention.

Do not remove the pressure cap from a HOT radiator. Allow radiator to cool down before removing pressure cap.

Transport

When loading or transporting machines ensure that the specified lifting and tie down points are used.

When loading or transporting machines ensure that the towing vehicle, its size, weight, towing hitch and electrical supply are all suitable to provide safe and stable towing at speeds either, up to the legal maximum for the country in which it is being towed or, as specified for the machine model if lower than the legal maximum.

Ensure that the maximum trailer weight does not exceed the maximum gross weight of the machine (by limiting the equipment load), limited by the capacity of the running gear.

NOTE: Gross mass (on data plate) is for the basic machine and fuel only, excluding any fitted options, tools, equipment and foreign materials.

Before towing the machine, ensure that:-

- the tyres and towing hitch are in a serviceable condition.
- the canopy is secure.
- all ancillary equipment is stored in a safe and secure manner.
- the brakes and lights are functioning correctly and meet necessary road traffic requirements
- break-away cable/safety chains are connected to the towing vehicle.

The machine must be towed in a level altitude in order to maintain correct handling, braking and lighting functions. This can be achieved by correct selection and adjustment of the vehicle towing hitch and, on variable height running gear, adjustment of the drawbar.

Make sure wheels, tyres and tow bar connectors are in safe operating condition and tow bar is properly connected before towing.

Steps for determining correct load limit:

1. Locate the statement "The weight of cargo should never exceed xxx kg or xxx lbs" on your vehicle's placard.
2. This figure equals the available amount of cargo and luggage load capacity.
3. Determine the combined weight of luggage and cargo being loaded on the vehicle. That weight may not safely exceed the available cargo and luggage load capacity.

Safety Chains/Connections and Their Adjustment

Where brakes and safety chains are fitted:

- a. Loop the chains onto the towing vehicle using the towing vehicle hitch as an anchorage point, or any other point of similar strength.
- b. Ensure that the effective chain length is as short as possible whilst still allowing normal articulation of the trailer and effective operation of the breakaway cable.

Where safety chains only are fitted:

- a. Loop the chains onto the towing vehicle using the towing vehicle hitch as an anchorage point, or any other point of similar strength.
- b. When adjusting the safety chains there should be sufficient free length in the chains to allow normal articulation, whilst also being short enough to prevent the towbar from touching the ground in the event of an accidental separation of the towing vehicle from the trailer.

*****Always use Ingersoll-Rand Replacement parts!*****



General Arrangement



General Arrangement

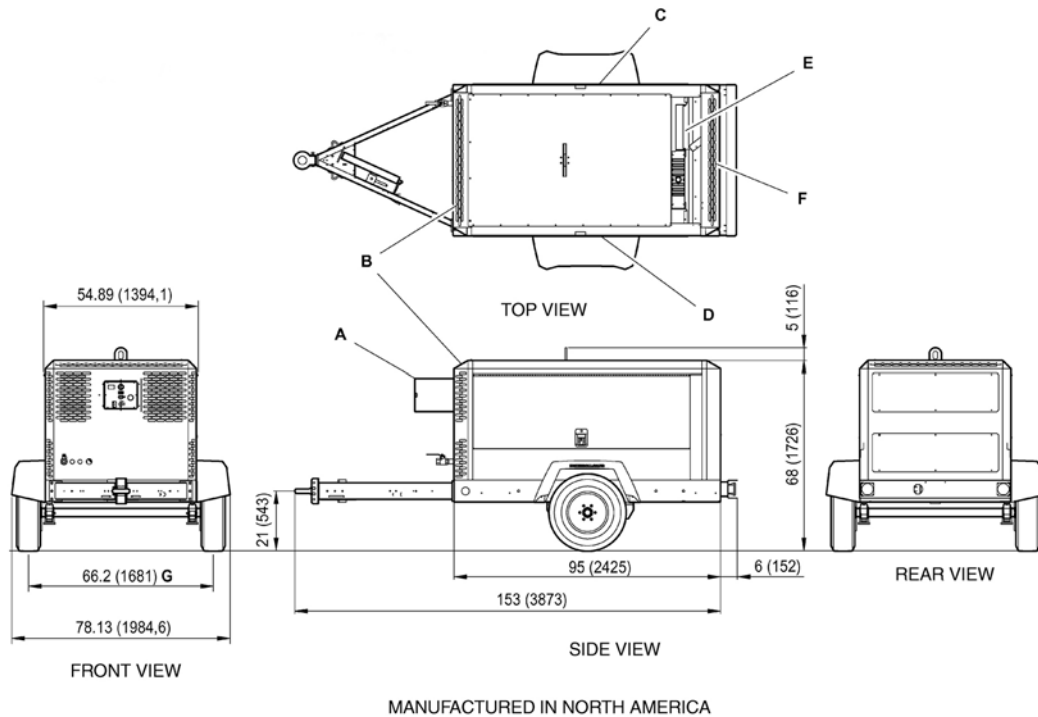

All dimensions in inches(mm)

A Instrument panel access door

B Package air inlet

C Access items:

Separator element & fill

Compressor oil filter

Fuel filters

Dipstick

Engine oil fill

Coolant bottle fill

D Access items:

Fuel fill

Engine oil filter

Fuel filter

Engine and compressor air filter

E Access items:

Radiator fill

F Package air outlet

G Track width

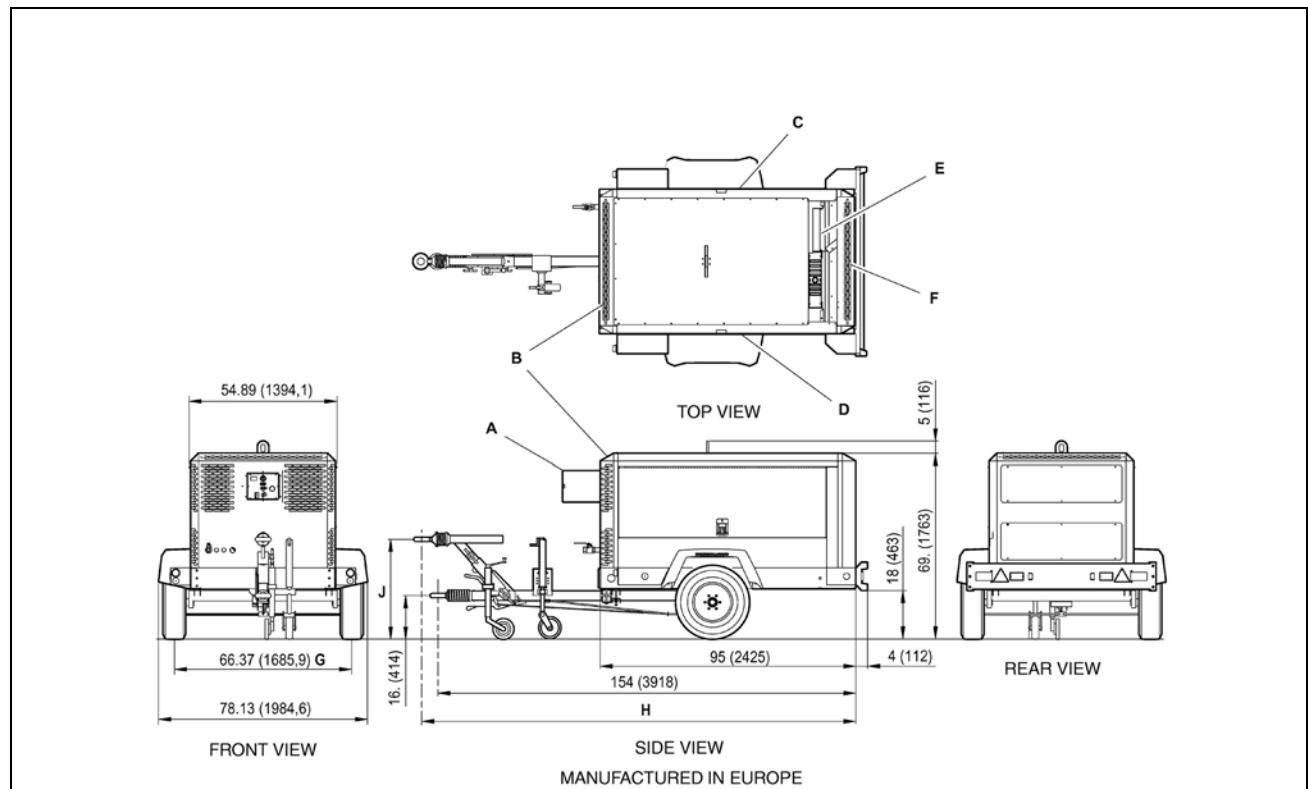

All dimensions in inches(mm)

A Instrument panel access door

B Package air inlet

C Access items:

Separator element & fill

Compressor oil filter

Fuel filters

Dipstick

Engine oil fill

Coolant bottle fill

D Access items:

Fuel fill

Engine oil filter

Fuel filter

Engine and compressor air filter

E Access items:

Radiator fill

F Package air outlet

G Track width

H Variable height drawbar

162 (4114) minimum/168 (4277) maximum

J Variable height drawbar

17 (420) minimum/35 (880) maximum

Compressor

COMPRESSOR

Actual free air delivery. (P425)	12, 0 m ³ min ⁻¹ (425 CFM)
Actual free air delivery. (XP375)	10, 5 m ³ min ⁻¹ (375 CFM)
Actual free air delivery. (HP375)	10, 5 m ³ min ⁻¹ (375 CFM)
Actual free air delivery. (VHP300)	8, 5 m ³ min ⁻¹ (300 CFM)
Normal operating discharge pressure. (P425)	7 bar (100 PSI)
Normal operating discharge pressure. (XP375)	8, 6 bar (125 PSI)
Normal operating discharge pressure. (HP375)	10, 3 bar (150 PSI)
Normal operating discharge pressure. (VHP3000)	14 bar (200 PSI)
Maximum allowable pressure. (P425)	8,6 bar (125 PSI)
Maximum allowable pressure. (XP375)	10.3 bar (150 PSI)
Maximum allowable pressure. (HP375)	12.1 bar (175 PSI)
Maximum allowable pressure. (VHP300)	15.5 bar (225 PSI)
Safety valve setting. (P425)	10 bar (150 PSI)
Safety valve setting. (XP375)	10 bar (200 PSI)
Safety valve setting. (HP375)	14 bar (200 PSI)
Safety valve setting. (VHP300)	17 bar (250 PSI)
Maximum pressure ratio (absolute). (P425)	7, 9: 1
Maximum pressure ratio (absolute). (XP375)	9, 6: 1
Maximum pressure ratio (absolute). (HP375)	11, 3: 1
Maximum pressure ratio (absolute). (VHP300)	14, 8: 1

Operating ambient temperature. Whisperized	-12°C TO +49°C(10°F TO 120°F)
Maximum discharge temperature	120°C (248°F)
Cooling system.	Oil injection
Oil capacity.	36 litres (9.5 GAL)
Maximum oil system temperature.	120°C (248°F)
Maximum oil system pressure. (P425)	8,6 bar (125 PSI)
Maximum oil system pressure. (XP375)	10.3 bar (150 PSI)
Maximum oil system pressure. (HP375)	12.1 bar (175 PSI)
Maximum oil system pressure. (VHP300)	15.5 bar (225 PSI)

Lubricating Oil Specification

LUBRICATING OIL SPECIFICATION

(for the specified ambient temperatures).

ABOVE -23°C(-9°F)

Recommended: Pro-Tec™

Approved: SAE 10W, API CF-4/CG-4

BELOW -23°C(-9°F)

Mandatory: IR Performance 500

Ingersoll-Rand Pro-Tec™ compressor fluid is factory-fitted, for use at all ambient temperatures above -23°C(-9°F).

NOTE: Warranty may be extended only by continuous use of Pro-Tec™ and Ingersoll-Rand oil filters and separators.

No other oil/fluids are compatible with Pro-Tec™

No other oils/fluids should be mixed with Pro-Tec™ because the resulting mixture could cause damage to the airend.

In the event that Pro-Tec™ is not available and /or the end user needs to use an approved single grade engine oil, the complete system including separator/receiver, cooler and pipework must be flushed clear of the first fill fluid and new Ingersoll-Rand oil filters installed.

When this has been completed, the following oils are approved:

- a. for ambient temperatures above -23°C(-9°F), SAE 10W, API CF-4/CG-4
- b. for ambient temperatures below -23°C(-9°F), I-R Performance 500 only.

Safety data sheets can be obtained on request from the lubricant supplier.

For temperatures outside the specified ambient range, consult Ingersoll-Rand.

Engine

Type/model.	Ingersoll-Rand
Number of cylinders.	4
Oil capacity.	13.2 litres (3.5 GAL)
Speed at full load. min ⁻¹ (RPM)	2400 revs
Speed at idle. (RPM)	1400 revs min ⁻¹
Electrical system.	24V negative earth
Power available at 2400 revs min ⁻¹	93 kW (125 HP)
Fuel tank capacity	219.5 litres (58 GAL)
Oil specification	Refer engine section
Coolant capacity	17 litres(4.5 GAL)

SOUND LEVEL DATA ('W' model)

EPA Noise	76 dB(A)
-----------	----------

WHEELS AND TIRES -

Number of wheels.	2 x 5.5
Tire Size	ST225/75R15(D)
Tire Pressure	=65 psi (4.5 bar)

Further information may be obtained by request through Ingersoll-Rand customer services department.

Commissioning

Upon receipt of the unit, and prior to putting it into service, it is important to adhere strictly to the instructions given below in *PRIOR TO STARTING*.

Ensure that the operator reads and *understands* the decals and consults the manuals before maintenance or operation.

Ensure that the position of the *emergency stop* device is known and recognised by its markings. Ensure that it is functioning correctly and that the method of operation is known.

Before towing the unit, ensure that the tyre pressures are correct (refer to the *GENERAL INFORMATION* section of this manual). Before towing the unit during the hours of darkness, ensure that the lights are functioning correctly (where fitted).

Ensure that all transport and packing materials are discarded.

Ensure that the correct fork lift truck slots or marked lifting/tie down points are used whenever the machine is lifted or transported.

When selecting the working position of the machine ensure that there is sufficient clearance for ventilation and exhaust requirements, observing any specified minimum dimensions (to walls, floors etc.).

Adequate clearance needs to be allowed around and above the machine to permit safe access for specified maintenance tasks.

Ensure that the machine is positioned securely and on a stable foundation. Any risk of movement should be removed by suitable means, especially to avoid strain on any rigid discharge piping.

Attach the battery cables to the battery(s) ensuring that they are tightened securely. Attach the negative cable before attaching the positive cable.

WARNING

All air pressure equipment installed in or connected to the machine must have safe working pressure ratings of at least the machine rated pressure, and materials compatible with the compressor lubricant (*refer to the GENERAL INFORMATION section*).

WARNING

If more than one compressor is connected to one common downstream plant, effective check valves and isolation valves must be fitted and controlled by work procedures, so that one machine cannot accidentally be pressurized/over pressurised by another.

WARNING

If flexible discharge hoses are to carry more than 7 bar (100psi) pressure then it is recommended that safety retaining wires are used on the hoses.

Operating Instructions



Operating Instructions

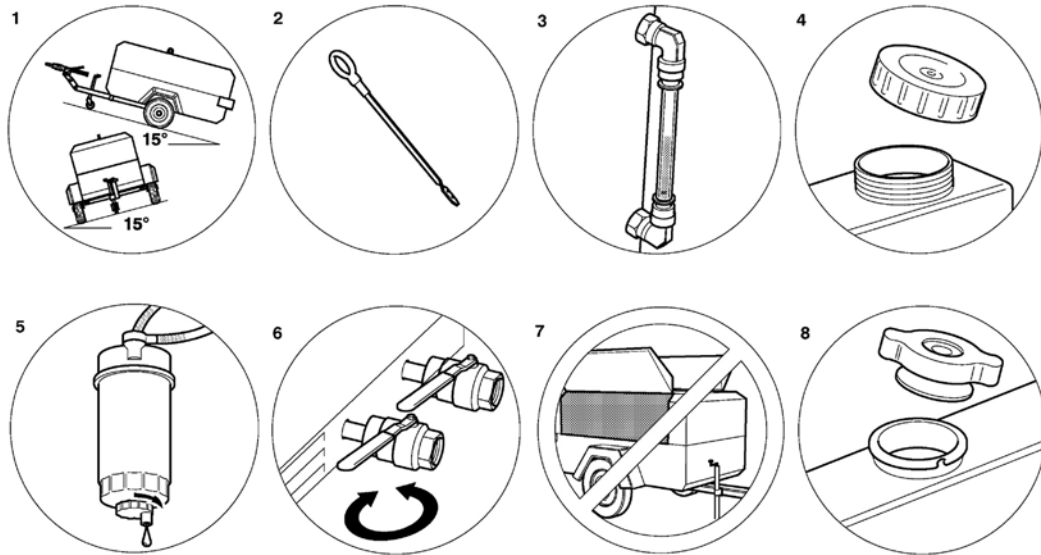

Prior to Starting

1. Place the unit in a position that is as level as possible. The design of the unit permits a 15 degree lengthways and sideways limit on out of level operation. It is the engine, not the compressor, that is the limiting factor.

When the unit has to be operated out of level, it is important to keep the engine oil level near the high level mark (with the unit level).

⚠ CAUTION

Do not overfill either the engine or the compressor with oil.

2. Check the engine lubrication oil in accordance with the operating instructions in the *Engine Operator's Manual*.
3. Check the compressor oil level in the sight glass located on the separator tank.
4. Check the diesel fuel level. A good rule is to top up at the end of each working day. This prevents condensation from occurring in the tank.

 **CAUTION**

Use only a No. 2-D diesel fuel oil with a minimum octane number of 45 and a sulphur content not greater than 0.5%.

 **CAUTION****When refuelling:-**

- *switch off the engine.*
 - *do not smoke.*
 - *extinguish all naked lights.*
 - *do not allow the fuel to come into contact with hot surfaces.*
 - *wear personal protective equipment.*
5. Drain the fuel filter water separator of water, ensuring that any released fuel is safely contained.
 6. Open the service valve(s) to ensure that all pressure is relieved from the system. Close the service valve(s).
 - 7.

 **CAUTION**

Do not operate the machine with the canopy/doors in the open position as this may cause overheating and operators to be exposed to high noise levels.

8. Check the radiator coolant level (with the unit level).

Check the air restriction indicator(s). Refer to the *MAINTENANCE* section of this manual.

When starting or operating the machine in temperatures below or approaching 0°C, ensure that the operation of the regulation system, the unloader valve, the safety valve, and the engine are not impaired by ice or snow, and that all inlet and outlet pipes and ducts are clear of ice and snow.

Control Panel

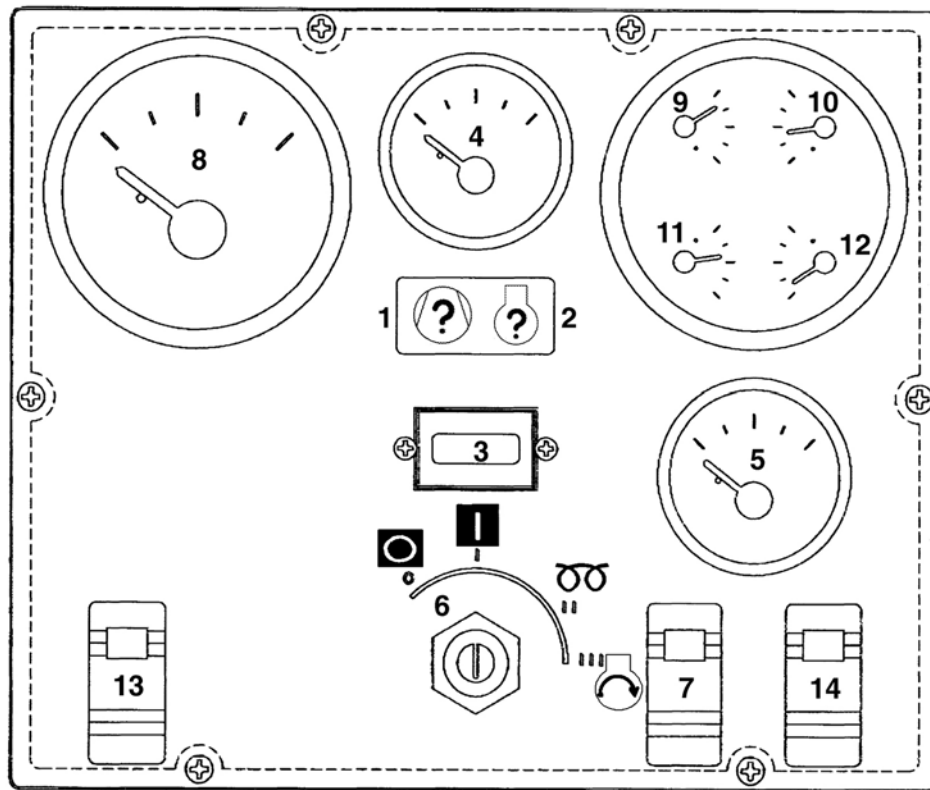

Diagnostic/Auto Shutdown (Standard)

1. **Compressor Fault** - Needs attention. See Wedge diagnostic panel for more detail.
2. **Engine Fault** - Needs attention. See Wedge diagnostic panel for more detail.
3. **Hourmeter** - Records running time for maintenance.
4. **Compressor Discharge Pressure Gauge** - Indicates pressure in receiver tank, psi (kPa).
5. **Fuel Level Gauge** - Indicates amount of fuel in tank.

CONTROLS (STANDARD)

6. **Power Switch** - Flip "ON" to activate systems prior to starting. Flip "OFF" to stop engine.
7. **Service Air Switch** - After warm-up, PUSH. Provides full air pressure at the service outlet.

Optional Controls

8. **Engine Speed Gauge** - Indicates engine speed.
9. **Discharge Air Temp. Gauge** - Indicates in °F and °C. Normal operating range: 185°F/85°C to 248°F/120°C.
10. **Engine Oil Pressure Gauge** - Indicates engine oil pressure (psi (kPa)).
11. **Engine Water Temp Gauge** - Indicates coolant temperature with normal operating range from 180°F/82°C to 210°F/99°C.
12. **Voltmeter** - Indicates battery condition.
13. **Spare**
14. **Wait to Start Lamp.**

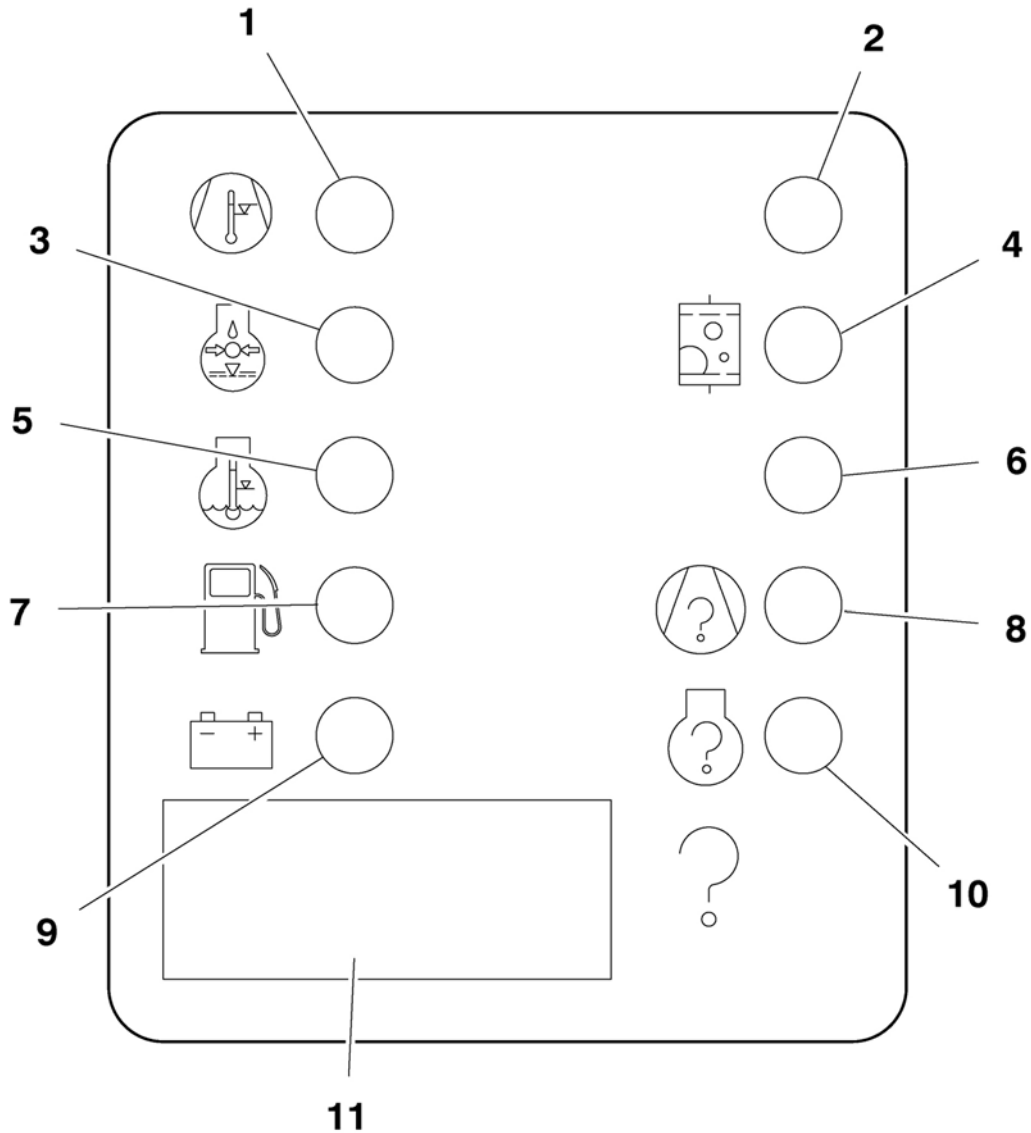

WEDGE DIAGNOSTIC DISPLAY PANEL.



The Wedge diagnostic display panel is arranged as shown above. A description of each diagnostic indicator is as follows:

1. **High Compressor Temp:** Fault indicator lamp. Indicates shutdown due to high compressor temperature.
2. **Spare**
3. **Low Engine Oil Pressure:** Fault indicator lamp. Indicates shutdown due to low engine oil pressure.



4. **Restricted Air Filter:** Alarm indicator lamp. Indicates engine/compressor air inlet filters need service.
5. **High Engine Coolant Temp:** Fault indicator lamp. Indicates shutdown due to high engine water temperature.
6. **Spare**
7. **Low Fuel Level:** Fault indicator lamp. Indicates shutdown due to low fuel level. Lamp blinks at low fuel warning.
8. **Compressor Malfunction:** Fault indicator lamp. Indicates shutdown due to compressor system fault. Refer to Fault Code List.
9. **Low Battery Voltage:** Alarm indicator lamp. Indicates battery or charging system requires service.
10. **Engine Malfunction:** Engine Fault code. Refer to service card or engine manual for codes and service requirements.
11. **Malfunction Code (4 Digit):** Compressor or engine fault. Refer to manual for list of codes and service requirements.

Wedge Diagnostic Display Codes



If the  fault indicator lamp is illuminated, refer to the  Alert/Shutdown list below.



If the  fault indicator lamp is illuminated, refer to the  Engine diagnostic list below.



ALERT/SHUTDOWN CONDITIONS Version: 1.40

Condition	Alert		Shutdown		Delay (sec).
	Code	Light (Blinks)	Code	Light (Steady)	
Engine Speed <900 RPM			1	CPRSR Malf.	30
Engine Speed >2500 RPM			2	CPRSR Malf.	30
Engine Crank Time Exceeded			3	CPRSR Malf.	0
Intake Manifold Temperature > 180 def. F	6	CPRSR Malf.			
Engine Not Responding To Throttle Command	10	CPRSR Malf.			

Condition	Alert		Shutdown		Delay (sec).
	Code	Light (Blinks)	Code	Light (Steady)	
Engine Shut Itself Down: reason unknown	29	CPRSR Malf.			
Disch. Temp (RT2) Sensor Fault			32	CPRSR Malf.	10
Sep. Tank Pressure (PT1) Sensor Fault	33	CPRSR Malf.			
Separator Tank Temp. >247 deg.F)			50	CPRSR Malf.	3
Machine ID Not Valid			51	CPRSR Malf.	0
Sep. Tank Temp. (RT1) Sensor Fault			53	CPRSR Malf.	10
Reg. System Pressure (PT2) Sensor Fault	54	CPRSR Malf.			
Serial Comm. Problem	70	CPRSR Malf.			
CAN Bus Problem	71	CPRSR Malf.			

Condition	Alert		Shutdown		Delay (sec).
	Code	Light (Blinks)	Code	Light (Steady)	
Dedicated Lights:					
Low Fuel Level		Fuel Level	1	Fuel Level	3
Air Filter Restriction (Option)		Soiled Filter			
Low Battery Voltage		Battery Charging Condition			
Engine Oil Pressure<18 PSI		Low Engine Oil Pressure			
Engine Coolant Temperature >=215 deg. F		High Engine Temp.			
Engine Coolant Temperature >=220 deg. F				High Comp. Temp.	10
High Discharge Temp. (RT2>247 deg. F)				High Comp. Temp.	3



ENGINE DIAGNOSTIC CODES

Listing of Diagnostic Trouble Codes (DTCs)		
Displayed Code	FMI*	Definition
28	8	Analog Throttle (B) Input Voltage High
	4	Analog Throttle (B) Input Voltage Low
29	3	Analog Throttle (A) Input Voltage High
	4	Analog Throttle (A) Input Voltage Low
91	3	Multi-state Throttle Input Voltage High
	4	Multi-state Throttle Input Voltage Low
100	1	Engine Oil Pressure Extremely Low
	3	Engine Oil Pressure Input Voltage High
	4	Engine Oil Pressure Input Voltage Low
	18	Engine Oil Pressure Moderately Low
105	3	Manifold Air Temperature Input Voltage High
	4	Manifold Air Temperature Input Voltage Low
	16	Manifold Air Temperature Moderately High
110	0	Engine Coolant Temperature High Most Severe
	3	Engine Coolant Temperature Input Voltage High
	4	Engine Coolant Temperature Input Voltage Low
	15	Engine Coolant Temperature High Least Severe
	16	Engine Coolant Temperature High Moderately Severe
158	17	ECU Power Down Error
174	3	Fuel Temperature Input Voltage High
	4	Fuel Temperature Input Voltage Low
	16	Fuel Temperature Moderately High
190	0	Engine Overspeed Extreme
	16	Engine Overspeed Moderate
620	3	Sensor Supply Voltage High
	4	Sensor Supply Voltage Low

Listing of Diagnostic Trouble Codes (DTCs)		
Displayed Code	FMI*	Definition
637	2	Crankshaft Position Input Noise
	10	Crankshaft Position Input Pattern Error
970	31	Auxiliary Engine Shutdown Switch Active
971	31	External Engine Derate Switch Active
1076	0	Pump Control Valve Closure Too Long
	1	Pump Control Valve Closure Too Short
	5	Pump Solenoid Circuit Open
	6	Pump Solenoid Circuit Severely Shorted
	7	Pump Control Valve Closure Not Detected
	10	Pump Solenoid Circuit Moderately Shorted
1109	31	Engine Shutdown Warning
1110	31	Engine Shutdown
1569	31	Fuel Derate
2000	6	Internal ECU Failure

***FMI (Failure Mode Indicator)-Requires engine diagnostic tool to display.**

Starting the Machine

WARNING

Under no circumstances should volatile liquids such as Ether be used for starting this machine.

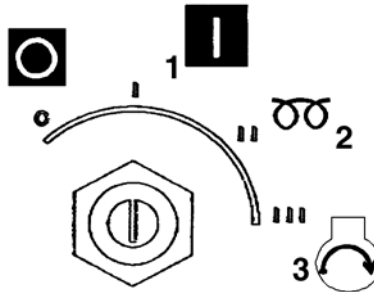

All normal starting functions are incorporated in the key operated switch.

- Turn the key switch to position 1. The engine fault and compressor fault lamps will flash.

Wait to Start Lamp.

- Turn the key switch to position 1 until the Wait To Start Lamp. (14) extinguishes.
- Turn the key switch to crank position (3) (engine start position)

NOTE: Position (2) not used on AWIR models.

- Release to position (1) when engine starts. The engine will now be running at a reduced speed.

At temperatures below 0°C or if there is difficulty starting first time:

- Open the service valve fully, with no hose connected.
- Complete starting sequence above.
- Close service valve as soon as engine runs freely.
- Do not allow machine to run for long periods with service valve open.
- Allow the engine to reach operating temperature.
- At this point in the operation of the machine it is safe to apply full load to the engine.

NOTE: Wear hearing protection at all times when the engine is started with the service valve open and air is flowing from the valve.

Push After Warm Up

NOTE: In order to allow the machine to start at a reduced load, a valve, which is operated by a button located on the instrument panel, is incorporated in the regulation system. (The valve automatically returns to the start position when the machine is switched off and air pressure relieved from the system).

- Allow the engine to reach its operating temperature-then press the button(7).
- At this point in the operation of the machine it is safe to apply *full load* to the engine.

Dual Pressure when Fitted

Machines which operate in excess of 7 bar (100 psi) can optionally be fitted with a dual pressure switch inside the unit. This switch selects between 7 bar (100 psi) and the machine rated pressure, cfm remains nominally constant.

Starting and stopping are unaffected by the selection and during normal running the selector switch may be safely operated. Precaution must be taken to ensure that downstream equipment is rated to suit the available pressure.

The pressure gauge indicates which setting has been selected.

Stopping the Machine

- Close the service valve.
- Allow the machine to run unloaded for a short period of time to reduce the engine temperature.
- Turn the start switch to the 0 (off) position.

NOTE: As soon as the engine stops, the automatic blowdown valve will relieve all pressure from the system.

If the automatic blowdown valve fails to operate, then pressure must be relieved from the system by means of the service valve(s).



Never allow the machine to stand idle with pressure in the system.

Emergency Stopping

In the event that the unit has to be stopped in an emergency. **TURN THE KEY SWITCH LOCATED ON THE INSTRUMENT PANEL TO THE 0 (OFF) POSITION.**

Re-Starting After an Emergency

If the machine has been switched off because of a machine malfunction, then identify and correct the fault before attempting to re-start.

If the machine has been switched off for reasons of safety, then ensure that the machine can be operated safely before re-starting.

Refer to the *PRIOR TO STARTING* and *STARTING THE UNIT* instructions earlier in this section before re-starting the machine.

Monitoring During Operation

Should any of the safely shut-down conditions occur, the unit will stop.

Refer to the Wedge diagnostic display codes table for a listing of shutdown conditions.

CAUTION

To ensure an adequate flow of oil to the compressor at low temperature, never allow the discharge pressure to fall below 3,5 bar (50 psi)

Decommissioning

When the machine is to be permanently decommissioned or dismantled, it is important to ensure that all hazard risks are either eliminated or notified to the recipient of the machine. In particular:-

- Do not destroy batteries or components containing asbestos without containing the materials safely.
- Do not dispose of any pressure vessel that is not clearly marked with its relevant data plate information or rendered unusable by drilling, cutting etc.
- Do not allow lubricants or coolants to be released into land surfaces or drains.
- Do not dispose of a complete machine without documentation relating to instructions for its use.

Engine

Engine Serial Number Plate

Each engine has a 13-digit engine serial number.

The engine's serial number plate is located on the right-hand side of cylinder block behind the fuel filter.

Fuels, Lubricants and Coolant

Diesel Fuel

Consult your local fuel distributor for properties of the diesel fuel available in your area.

In general, diesel fuels are blended to satisfy the low temperature requirements of the geographical area in which they are marketed.

Diesel fuels specified to EN 590 or ASTM D975 are recommended.

Required Fuel Properties

In all cases, the fuel must meet the following properties:

Cetane number of 45 minimum. Cetane number greater than 50 is preferred, especially for temperatures below -20°C (-4°F) or elevations above 1500 m (5000 ft).

Cold Filter Plugging Point (CFPP) below the expected low temperature OR **Cloud Point** at least 5°C (9°F) below the expected low temperature.

Fuel lubricity should pass a minimum load level of 3100 grams as measured by ASTM D6078 or, maximum scar diameter of 0.45 mm as measured by ASTM D6079.

Sulfur Content:

- Diesel fuel quality and fuel sulfur content must comply with all existing regulations for the area in which the engine operates.
- Sulfur content less than 0.05% (500 ppm) is preferred.
- If diesel fuel with sulfur content greater than 0.05% (500 ppm) is used, crankcase oil service intervals may be affected. (See recommendation for Diesel Engine Oil).
- DO NOT use diesel fuel with sulfur content greater than 1.0%.

IMPORTANT: DO NOT mix used engine oil or any other type of lubricating oil with diesel fuel.

Bio-Diesel Fuel

Bio-diesel fuels may be used ONLY if the bio-diesel fuel properties meet the latest edition of ASTM PS121, DIN 51606 or equivalent specification.

It has been found that bio-diesel fuels may improve lubricity in concentrations up to a 5% blend in petroleum diesel fuel.

When using a blend of bio-diesel fuel, the engine oil level must be checked daily when the air temperature is -10°C (14°F) or lower. If the oil becomes diluted with fuel, shorten oil change intervals accordingly.

IMPORTANT: Raw pressed vegetable oils are NOT acceptable for use for fuel in any concentration.

These oils do not burn completely, and will cause engine failure by leaving deposits on injectors and in the combustion chamber.

Handling and Storing Bio-Diesel Fuel



Handle fuel carefully. Do not fill the fuel tank when engine is running.

DO NOT smoke while you fill the fuel tank or service the fuel system.

Fill the fuel tank at the end of each day's operation to prevent water condensation and freezing during cold weather.

Keep all storage tanks as full as practicable to minimize condensation.

Ensure that all fuel tank caps and covers are installed properly to prevent moisture from entering.

Monitor water content of the fuel regularly.

Fuel filter may require more frequent replacement due to premature plugging.

Check engine oil level daily prior to starting engine. A rising oil level may indicate fuel dilution of the engine oil.

When fuel is stored for an extended period or if there is a slow turnover of fuel, add a fuel conditioner to stabilize the fuel and prevent water condensation. Contact your fuel supplier for recommendations.

Diesel Fuel Storage



Handle fuel carefully. Do not fill the fuel tank when engine is running.

DO NOT smoke while you fill the fuel tank or service the fuel system.

Fill the fuel tank at the end of each day's operation to prevent water condensation and freezing during cold weather.

IMPORTANT: DO NOT store diesel fuel in galvanized containers. Diesel fuel stored in galvanized containers reacts with zinc coating on container to form zinc flakes. If fuel contains water, a zinc gel will also form. The gel and flakes will quickly plug fuel filters, damage injection nozzles and injection pump.

DO NOT use brass-coated containers for fuel storage. Brass is an alloy of copper and zinc.

Store diesel fuel in plastic, aluminum, and steel containers specially coated for diesel fuel storage.

Avoid storing fuel over long periods of time. If fuel is stored for more than a month prior to use, other than a slow turnover in fuel tank or supply tank, add a fuel conditioner to stabilize the fuel, prevent water condensation.

Minimizing the Effect of Cold Weather on Diesel Engines

Ingersoll-Rand diesel engines are designed to operate effectively in cold weather.

See your authorized engine distributor or servicing dealer for additional information and availability of cold weather aids.

Use Grade No. 1-D Fuel

When temperatures fall below 5°C (40°F), Grade No. 1-D fuel is best suited for cold weather operation.

Diesel Fuel Additive

IMPORTANT: Treat fuel when outside temperature drops below 0°C (32°F). For best results, use with untreated fuel. Follow all recommended instructions on label.

Use a fuel conditioner (Winter) to treat fuel during the cold weather season. Winter formulation is a combination diesel fuel conditioner and anti-gel additive.

Diesel Engine Oil

Use SAE 15W-40 oil viscosity based on the expected air temperature range of 10°F to 122°F (-12°C-40°C) during the period between oil changes.

The following oil is preferred:

- Pro-Tec™ Engine Fluid

Other oils may be used if they meet one or more of the following:

- API Service Classification CI-4
- API Service Classification CH-4
- ACEA Specification E3
- ACEA Specification E4
- ACEA Specification E5

Multi-Viscosity Diesel Engine Oils are Preferred.

Diesel fuel quality and sulfur content must comply with all existing emissions regulations for the area in which the engine operates.

If diesel fuel with sulfur content greater than 0.05% (500 ppm) is used, reduce the oil and filter change interval by 100 hours.

If diesel fuel with sulfur content greater than 0.5% (5000 ppm) is used, reduce the service interval by 50%.

Diesel fuel with sulfur content greater than 1.0% (10,000 ppm) is not recommended.

Diesel Engine Coolant

The engine cooling system is filled to provide year-round protection against corrosion and cylinder liner pitting, and winter freeze protection to -37°C (-34°F).

Low silicate ethylene glycol base coolants for heavy-duty engines may be used if they meet one of the following specifications:

- ASTM D5345 (pre-diluted coolant)
- ASTM D4985 (coolant concentrate) in a 40 to 60% mixture of concentrate with quality water.

Coolants meeting these specifications require use of supplemental coolant additives, formulated for heavy-duty diesel engines, for protection against corrosion and cylinder liner erosion and pitting.

A 50% mixture of ethylene glycol engine coolant in water provides freeze protection to -37°C (-34°F). If protection at lower temperatures is required, consult your dealer for recommendations.

Water quality is important to the performance of the cooling system. Distilled, or demineralized water is recommended for mixing with ethylene glycol base engine coolant concentrate.

Chlorides	<40mg/L
Sulfates	<100 mg/L
Total Dissolved Solids	<340 mg/L
Total Hardness	<170 mg/L
pH	5.5 to 9.0

IMPORTANT: Do not use cooling system sealing additives or antifreeze that contains sealing additives.

Supplemental Coolant Additives

The concentration of coolant additives is gradually depleted during engine operation. For all recommended coolants, replenish additives between drain intervals by adding a supplemental coolant additive every 12 months.

IMPORTANT: Only use coolant additive to replenish the coolant. Do not use additive when the entire system is drained and refilled.

Consult the coolant supplier and follow the manufacturer's recommendation for use of supplemental coolant additives.

The use of non-recommended supplemental coolant additives may result in additive drop-out and gelation of the coolant.

Add the manufacturer's recommended concentration of supplemental coolant additive. DO NOT add more than the recommended amount.

Coolant Drain Intervals

Drain the factory fill engine coolant, flush the cooling system, and refill with new coolant after the first 3 years or 3000 hours of operation. Subsequent drain intervals are determined by the coolant used for service. At each interval, drain the coolant, flush the cooling system, and refill with new coolant.

Operating in Warm Temperature Climates

Ingersoll-Rand engines are designed to operate using glycol base engine coolants.

Always use a recommended glycol base engine coolant, even when operating in geographical areas where freeze protection is not required.

IMPORTANT: Water may be used as coolant in emergency situations only.

Foaming, hot surface aluminum and iron corrosion, scaling, and cavitation will occur when water is used as the coolant, even when coolant conditioners are added.

Drain cooling system and refill with recommended glycol base engine coolant as soon as possible.

Engine Break-In Service

The engine is ready for normal operation. However, extra care during the first 100 hours of operation will result in more satisfactory long-term engine performance and life. **DO NOT** exceed 100 hours of operation with break-in oil.

*****Always use Ingersoll-Rand Replacement parts!*****



Lubrication



Lubrication

Lubrication and Maintenance Service Interval Chart

NOTE: The Service intervals below are for standard industrial engines. See details in Sections which follow these charts.

Item	<u>Lubrication and Maintenance Service Intervals</u>			
	Daily	500 Hours/ 12months	2000 Hours/ 24months	As Required
Check Engine Oil and Coolant Level				
Check Fuel Filter/Water Bowl	•			
Check Air Cleaner Dust Unloader Valve & Restriction Indicator Gauge	•			
Visual Walk Around Inspection	•	•		
Service Battery		•		
Check Manual Belt Tensioner and Belt Wear		•		
Check Engine Oil and Replace Oil Filter		•		
Clean Crankcase Vent Tube		•		
Check Air Intake Hoses, Connections, & System		•		
Replace Fuel Filter Elements-Bleed Fuel System		•		
Check Belt Tensioner and Belt Wear		•		
Check Engine Electrical Ground Connection		•		
Check Cooling System		•		
Pressure Test Cooling System		•		
Flush Cooling System			•	
Test Thermostats			•	
Check and Adjust Engine Valve Clearance			•	
Add Coolant				•
Replace Air Cleaner Elements				•
Replace Poly-Vee Belt				•
A Replace primary air cleaner element when restriction indicator shows a vacuum of 625 mm (25 in.) H ₂ O				
B During engine break-in, change the oil and filter for the first time before 100 hours of operation.				
C If the recommended engine oils, or Pro-Tec™ is not used, the oil and filter change interval is reduced to every 250 hours. If diesel fuel with a sulfur content greater than 0.05% is used, the oil and filter change interval is also reduced.				

Lubrication & Maintenance/Daily

Daily Pre-starting Checks

Do the following BEFORE STARTING THE ENGINE for the first time each day:

Check engine oil level on dipstick.

IMPORTANT: DO NOT add makeup oil until the oil level is below the crosshatch marks on the dipstick.

IMPORTANT: DO NOT fill above the top mark on the dipstick. Oil levels anywhere within crosshatch are considered in the acceptable range.

To change engine oil and oil filter:

Check the fuel filters for water or debris. If filter is fitted with a see-through bowl, drain as needed based on a daily visual inspection.

IMPORTANT: Drain water into a suitable container and dispose of properly.

- a. Loosen drain plugs (A) at bottom of fuel filters or bowls, if equipped, two or three turns.
- b. Loosen air bleed plug (B) two full turns on fuel filter mounting and drain water from bottom until fuel starts to drain out.
- c. When fuel starts to drain out, tighten drain plugs securely.

After draining water from the fuel filters, the filters must be primed by bleeding all air from the fuel system.

Changing Engine Oil and Replacing Filter

Your engine is equipped with a special oil filter.

NOTE: During break-in, change engine oil and filter for the first time before 100 hours maximum of operation.

After break-in, the oil and filter change interval is 500 hours or every 12 months, whichever comes first.

NOTE: If diesel fuel with a sulfur content greater than 0.05% (500 ppm) is used, the oil and filter change interval is reduced.

To change engine oil and oil filter:

1. Run engine approximately 5 minutes to warm up oil. Shut engine off.
2. Remove oil pan drain plug.
3. Drain crankcase oil from engine while warm.
4. Turn filter element using a suitable filter wrench to remove. Discard oil filter element.

Important: Filtration of oils is critical to proper lubrication. Always change filter regularly.

5. Apply clean engine oil to the new filter at the inner and outer seals and to filter threads.
6. Wipe both sealing surfaces of the header with a clean rag. Ensure dust seal is in place, replace if damaged.

IMPORTANT: When installing filter element, HAND TIGHTEN only. A filter wrench may be used for REMOVAL ONLY.

7. Install and tighten oil filter by hand until firmly against dust seal. DO NOT apply an extra ¾ to 1-1/4 turn after gasket contact as done with standard filters.
8. Tighten drain plug to specifications.

Specification
Oil Pan Drain Plug With Copper Washer- Torque 70 N.m (52 lb ft)
Oil Pan Drain Plug With O-Ring- Torque 50 N.m (37 lb ft)

9. Fill engine crankcase with pro-Tec™ Engine Fluid.

To determine the correct oil fill quantity for your engine, see ENGINE CRANKCASE OIL FILL QUANTITIES in the Specifications Section of this manual.

IMPORTANT: Immediately after completing any oil change, crank engine for 30 seconds without permitting engine to start. This will help insure adequate lubrication to engine components before engine starts.

NOTE: Crankcase oil capacity may vary slightly. ALWAYS fill crankcase within crosshatch marks on dipstick. DO NOT overfill.

10. Start engine and run to check for possible leaks.
11. Stop engine and check oil level after 10 minutes. Oil level reading should be within crosshatch of dipstick.

Cleaning Crankcase Vent Tube

If you operate the engine in dusty conditions, clean the tube at shorter intervals.

1. Remove and clean crankcase vent tube.
2. Install the vent tube. Be sure the O-ring fits correctly in the rocker arm cover for elbow adapter.

Replacing Fuel Filter Elements

Engine is equipped with a primary fuel filter (or pre-filter) with water bowl and a final filter. Both filters are replaced at the same 500-hour interval.

CAUTION

Escaping fluid under pressure can penetrate the skin causing serious injury. Relieve pressure before disconnecting fuel or other lines. Tighten all connections before applying pressure. Keep hands and body away from pinholes and nozzles which eject fluids under high pressure. Use a piece of cardboard or paper to search for leaks. Do not use your hand.

1. Close fuel shut-off valve, if equipped.
2. Thoroughly clean fuel filter assemblies and surrounding areas.
3. Disconnect water sensor wiring (if equipped).
4. Loosen drain plugs and drain fuel into a suitable container.

NOTE: Lifting up on retaining ring as it is rotated helps to get it past raised locators.

5. Firmly grasp the retaining ring and rotate it counterclockwise $\frac{1}{4}$ turn. Remove ring with filter element.
6. Inspect filter mounting base for cleanliness. Clean as required.

NOTE: Raised locators on fuel filter canisters must be indexed properly with slots in mounting base for correct installation.

7. Install new filter elements onto mounting bases. Be sure elements are properly indexed and firmly seated on bases. It may be necessary to rotate filters for correct alignment.

If equipped with water separator bowl (E), remove filter element from separator bowl. Drain and clean separator bowl. Dry with compressed air. Install bowl onto new element. Tighten securely.

8. Align keys on filter element with slots in filter base.

9. Install retaining ring onto mounting base making certain dust seal is in place on filter base. Hand tighten ring (about 1/3 turn) until it "snaps" into the detent. DO NOT overtighten retaining ring.

NOTE: The proper installation is indicated when a "click" is heard and a release of the retaining ring is felt. A plug is provided with the new element for plugging the used element.

10. Reconnect water sensor wiring (if equipped).
11. Open fuel shut-off valve and bleed the fuel system.

Checking Belt Tensioner Spring Tension and Belt Wear (Automatic Tensioner)

Belt drive systems equipped with automatic (spring) belt tensioners cannot be adjusted or repaired. The automatic belt tensioner is designed to maintain proper belt tension over the life of the belt. If tensioner spring tension is not within specification, replace tensioner assembly.

Checking Belt Wear

The belt tensioner is designed to operate within the limit of arm movement provided by the case stops when correct belt length and geometry is used.

Visually inspect cast stops on belt tensioner assembly.

If the tensioner stop on swing arm is hitting the fixed stop, check mounting brackets (alternator, belt tensioner, idler pulley, etc.) and the belt length. Replace belt as needed

Checking Tensioner Spring Tension

A belt tension gauge will not give an accurate measure of the belt tension when automatic spring tensioner is used. Measure tensioner spring tension using a torque wrench and procedure outlined below:

1. Release tension on belt using a breaker bar and socket on tension arm. Remove belt from pulleys.
2. Release tension on tension arm and remove breaker bar.
3. Put a mark on swing arm of tensioner as shown.
4. Measure 21 mm (0.83 in.) and put a mark on tensioner mounting base.
5. Install torque wrench so that it is aligned with centers of pulley and tensioner. Rotate the swing arm using a torque wrench until marks are aligned.
6. Record torque wrench measurement and compare with specification below. Replace tensioner assembly as required.

Specification
Spring Tension-Torque 18-22 N.m (13-16 lb-ft)

NOTE: Threads on belt tensioner roller cap screw are LEFT-HAND threads.

Checking Engine Electrical Ground Connections

Keep all engine ground connections clean and tight to prevent electrical arcing which can damage electronic components.

Replenishing Supplemental Coolant Additives (SCAs) Between Coolant Changes

NOTE: If system is to be filled with coolant that does not contain SCAs, the coolant must be precharged.

Through time and use, the concentration of coolant additives is gradually depleted during engine operation. Periodic replenishment of inhibitors is required. The cooling system must be recharged with additional supplemental coolant additives available in the form of liquid coolant conditioner.

Maintaining the correct coolant conditioner concentration (SCAs) and freeze point is essential in your cooling system to protect against rust, liner pitting and corrosion, and freeze-ups due to incorrect coolant dilution.

DO NOT mix one brand of SCA with a different brand.

Recharge the system per instructions printed on label of the Coolant Conditioner.

IMPORTANT: Always maintain coolant at correct level and concentration. DO NOT operate engine without coolant even for a few minutes.

If frequent coolant makeup is required, the glycol concentration should be checked to ensure that the desired freeze point is maintained. Follow manufacturer's instructions provided with Coolant/Battery Tester.

Add the manufacturer's recommended concentration of supplemental coolant additive. DO NOT add more than the recommended amount.

The use of non-recommended supplemental coolant additives may result in additive drop-out and gelation of the coolant.

If other coolants are used, consult the coolant supplier and follow the manufacturer's recommendation for use of supplemental coolant additives.

Replacing Fan and Alternator Belts

Refer to CHECKING BELT TENSIONER SPRING TENSION AND BELT WEAR in Lubrication and Maintenance/500 Hour/12 Month Section for additional information on the belt tensioner.

1. Inspect belts for cracks, fraying, or stretched out areas. Replace if necessary.
2. To replace belt with automatic tensioner, release tension on belt using a breaker bar and socket on tension arm.

To replace belt with manual tensioner, release tension at belt tensioner.

3. Remove poly-vee belt from pulleys and discard belt.
4. Install new belt, making sure belt is correctly seated in all pulley grooves. Refer to belt routing at right for your application.
5. Apply tension to belt with tensioner. Remove socket.
6. Start engine and check belt alignment.

Bleeding the Fuel System

Bleed the Fuel System (Engines with Electronic Fuel Systems and Stanadyne DE10 Pump)

CAUTION

Escaping fluid under pressure can penetrate the skin causing serious injury. Avoid hazards by relieving pressure before disconnecting hydraulic or other lines. Tighten all connections before applying pressure. Search for leaks with a piece of cardboard. Protect hands and body from high pressure fluids.

Any time the fuel system has been opened up for service (lines disconnected or filters removed), it will be necessary to bleed air from the system.

The fuel system may be bled at one of several location. Choose the best location for your engine/machine application.

1. Loosen the air bleed vent screw two full turns by hand on fuel filter base.
2. Operate fuel supply pump primer lever (B) or primer button on fuel filter base (if equipped).
3. Tighten bleed plug securely, continue operating primer until pumping action is not felt.
4. Start engine and check for leaks.

At Fuel Injection Pump

1. Loosen fuel return line at fuel injection pump.
2. Operate fuel supply pump primer lever or primer button on fuel filter base (if equipped).
3. As soon as fuel flow is free from air bubbles, tighten fuel return line to specification. Primer lever is spring-loaded and will return to normal position.

Specification

Fuel Injection Pump Return

Line-Torque 27 N.m (20 lb-ft)

At Fuel Injection Nozzles

IMPORTANT: Always use a backup wrench when loosening or tightening fuel lines at nozzles and/or injection pump to avoid damage.

1. Using **two** open-end wrenches, loosen two fuel line connections at injection nozzles.
2. Crank engine over with starter motor for 15 second (but do not start engine) until fuel free from bubbles flows out of loosened connection. Retighten connection to specifications.

Specification

Fuel Injection Nozzle Delivery

Line-Torque 27 N.m (20 lb-ft)

3. Repeat procedure for remaining injection nozzles (if necessary) until all air has been removed from fuel system.

If engine still will not start, see your authorized servicing dealer or engine distributor.

Do Not Modify Fuel System

IMPORTANT: Modification or alteration of the injection pump, the injection pump timing, or the fuel injectors in ways not recommended by the manufacturer will terminate the warranty obligation to the purchaser.

In addition, tampering with fuel system which alters emission-related equipment on engines may result in fines or other penalties, per EPA regulations or other local emission laws.

Do not attempt to service injection pump or fuel injectors yourself. Special training and special tools are required. (See your authorized servicing dealer).

Troubleshooting

General Troubleshooting Information

Troubleshooting engine problems can be difficult.

In this section is a list of possible engine problems that may be encountered accompanied by possible causes and corrections. The illustrated diagrams and troubleshooting information are of a general nature. See your engine distributor or servicing dealer if you are in doubt.

A reliable program for troubleshooting engine problems should include the following basic diagnostic thought process:

- Know the engine and all related systems.
- Study the problem thoroughly.
- Relate the symptoms to your knowledge of engine and systems.
- Diagnose the problem starting with the easiest things first.
- Double-check before beginning the disassembly.
- Determine cause and make a thorough repair.
- After making repairs, operate the engine under normal conditions to verify that the problem and cause was corrected.

NOTE: The engines covered in this manual have electronic control systems which send diagnostic trouble codes to signal problems.

Precautions for Welding on Engines Equipped with Electronic Engine Control Unit (ECU)

IMPORTANT: ALWAYS disconnect Electronic Control Unit (ECU) connectors and engine control system-to-machine ground before welding on engine or machine. High currents or electro-static discharge in electronic components from welding may cause permanent damage.

1. Remove the ground connection for the engine control system-to-machine frame.
2. Disconnect the connectors from the ECU.
3. Connect the welder ground close to the welding point and be sure ECU or other electronic components are not in the ground path.

Symptom	Problem	Solution
Engine cranks but will not start	Incorrect starting procedure	Verify correct starting procedure.
	No fuel.	Check fuel in tank.
	Exhaust restricted.	Check and correct exhaust restriction.
	Fuel filter plugged or full of water	Replace fuel filter or drain water from filter.
	Injection pump not getting fuel or air in fuel system.	Check fuel flow at supply pump or bleed system.
Engine hard to start or will not start	Engine starting under load.	Disengage PTO
	Improper starting procedure.	Review starting procedure.
	No fuel.	Check fuel tank.
	Air in fuel line.	Bleed fuel line.
	Cold weather.	Use cold weather starting aids.
	Slow starter speed.	See "Starter Cranks Slowly".
	Crankcase oil too heavy.	Use oil of proper viscosity.
	Improper type of fuel.	Consult fuel supplier; use proper type fuel for operating conditions.
	Water, dirt, or air in fuel system	Drain, flush, fill, and bleed system.
	Clogged fuel filter.	Replace filter element.
	Dirty or faulty injection nozzles.	Have authorized servicing dealer or engine distributor check injectors.
Electronic fuel system problem if equipped	See your distributor or servicing dealer.	
Engine knocks	Low engine oil level.	Add oil to engine crankcase.
	Low coolant temperature.	Remove and check thermostat.
	Engine overheating.	See "Engine Overheats".
	Engine cold	Wrong or defective thermostat. Remove and check thermostat.

Symptom	Problem	Solution
Engine runs irregularly or stalls frequently	Low coolant temperature.	Remove and check thermostat.
	Clogged fuel filter.	Replace fuel filter element.
	Water, dirt, or air in fuel system.	Drain, flush, fill, and bleed system. Dirty or faulty injection nozzles. Have authorized servicing dealer check injectors.
	Electronic fuel system problem	See your distributor or servicing dealer.
Below normal Engine temperature	Defective thermostat.	Remove and check thermostat.
	Defective temperature gauge or sender.	Check gauge, sender, and connections.
Lack of power	Engine overloaded.	Reduce load.
	Intake air restriction.	Service air cleaner.
	Clogged fuel filter.	Replace filter elements.
	Improper type of fuel.	Use proper fuel.
	Overheated engine.	See "Engine Overheats".
	Below normal engine temperature.	Remove and check thermostat.
	Improper valve clearance.	See your authorized servicing dealer.
	Dirty or faulty injection nozzles.	Have authorized servicing dealer check injectors.
	Injection pump out of time.	See your authorized servicing dealer.
	Electronic fuel system problem	See your authorized servicing dealer.
	Turbocharger not functioning. (Turbocharger engines only)	See your authorized serving dealer.
	Leaking exhaust manifold gasket.	See your authorized servicing dealer.
	Defective aneroid control line.	See you authorized servicing dealer.
	Restricted fuel hose.	Clean or replace fuel hose.
Low fast idle speed.	See your authorized servicing dealer.	

Symptom	Problem	Solution
Low oil pressure	Low oil level.	Add oil
	Improper type of oil.	Drain, fill crankcase with oil of proper Viscosity and quality.
High oil consumption	Crankcase oil too light.	Use proper viscosity oil.
	Oil leaks.	Check for leaks in lines, gaskets, and drain plug.
	Restricted crankcase vent tube.	Clean vent tube.
	Defective turbocharger.	See your authorized servicing dealer.
Engine emits white smoke	Improper type of fuel.	Use proper fuel.
	Low engine temperature.	Warm up engine to normal operating temperature.
	Defective thermostat.	Remove and check thermostat.
	Defective injection nozzles.	See your authorized servicing dealer.
Engine emits black or gray exhaust smoke	Improper type of fuel.	Use proper fuel.
	Clogged or dirty air cleaner.	Service air cleaner.
	Engine overloaded.	Reduce load.
	Injection nozzles dirty.	See your authorized servicing dealer.
	Electronic fuel system problem	See your authorized servicing dealer.
	Turbocharger not functioning.	See your authorized servicing dealer.

Symptom	Problem	Solution
Engine overheats	Engine overloaded.	Reduce load.
	Low coolant level.	Fill radiator to proper level, check radiator and hoses for loose connections or leaks.
	Faulty radiator cap.	Have technician check.
	Stretched poly-vee belt or defective belt tensioner.	Check automatic belt tensioner and check belts for stretching. Replace as required.
	Low engine oil level.	Check oil level. Add oil as required.
	Cooling system needs flushing.	Flush cooling system.
	Defective thermostat.	Remove and check thermostat.
	Defective temperature gauge or sender.	Check coolant temperature with thermometer and replace, if necessary.
	Incorrect grade of fuel.	Use correct grade of fuel.
High fuel Consumption	Improper type of fuel.	Use correct grade of fuel.
	Clogged or dirty air cleaner.	Service air cleaner.
	Engine overloaded.	Reduce load.
	Improper valve clearance.	See your authorized servicing dealer.
	Injection nozzles dirty.	See your authorized servicing dealer.
	Electronic fuel system problem.	See your authorized servicing dealer.
	Defective turbocharger.	See you authorized servicing dealer
	Low engine temperature.	Check thermostat.
Undercharged electrical system	Excessive electrical load from added accessories.	Remove accessories or install higher output alternator.
	Excessive engine idling.	Increase engine rpm when heavy electrical load is used.
	Poor electrical connections on battery, ground strap, starter, or alternator.	Inspect and clean as necessary.
	Defective battery.	Test battery.
	Defective alternator.	Test charging system.

Symptom	Problem	Solution
Battery uses too much Water	Cracked battery case.	Check for moisture and replace as necessary.
	Defective battery.	Test battery.
	Battery charging rate too high.	Test charging system.
Batteries will not charge	Loose or corroded connections.	Clean and tighten connections.
	Sulfated or worn-out batteries.	See your authorized servicing dealer.
	Stretched poly-vee belt or defective belt tensioner.	Adjust belt tension or replace belts.
Starter will not crank	PTO engaged.	Disengage PTO.
	Loose or corroded connections.	Clean and tighten loose connections.
	Low battery output voltage.	See your authorized servicing dealer.
	Faulty start circuit replay.	See your authorized servicing dealer.
	Blown fuse	Replace fuse.
Starter cranks slowly	Low battery output.	See your authorized servicing dealer.
	Crankcase oil too heavy.	Use proper viscosity oil.
	Loose or corroded connections.	Clean and tighten loose connections.
Entire electrical system does not function	Faulty battery connection.	Clean and tighten connections.
	Sulfated or worn-out batteries.	See your authorized servicing dealer.

Displaying of Diagnostic Trouble Codes (DTCs)

Stored and active diagnostic trouble codes are output on the instrument panel according to the J1939 standard as a two-part code as shown on the tables in the Operating Instruction Section.

NOTE: The electronic instrument panel can have communication problems that result in Error Codes being shown on its LCD display window.

EE-Error XXXXX-EP
No Data

ACP-Err XXXXX-BO

The following Error Codes all indicate that there is a communication error with the ECU.

No Addr No Data
ACP-Err XXXXX-BR

Contact your servicing dealer for help in correcting these codes:

BUS-EP No Data

Intermittent Fault Diagnostics (With Electronic Controls)

Intermittent faults are problems that periodically "go away". A problem such as a terminal that intermittently doesn't make contact can cause an intermittent fault. Other intermittent may be set only under certain operating conditions such as heavy load, extended idle, etc. When diagnosing intermittent faults, take special note of the condition of wiring and connectors, since a high percentage of intermittent problems originate here. Check for loose, dirty or disconnected connectors. Inspect the wiring routing, looking for possible shorts caused by contact with external parts (for example, rubbing against sharp sheet metal edges). Inspect the connector vicinity, looking for wires that have pulled out of connectors, poorly positioned terminals, damaged connectors and corroded or damaged splices and terminals. Look for broken wires, damaged splices, and wire-to-wire shorts. Use good judgement if component replacement is thought to be required.

NOTE: The engine control unit (ECU) is the component LEAST likely to fail.

Suggestions for diagnosing intermittent faults:

- If the problem is intermittent, try to reproduce the operating conditions that were present when the diagnostic trouble code (DTC) set.

Observing these values can help determine the operating conditions when the fault occurred.

- If a faulty connection or wire is suspected to be the cause of the intermittent problem: clear DTCs, then check the connection or wire by wiggling it while watching the diagnostic gauge to see if the fault resets.

Possible causes of intermittent faults:

- Faulty connection between sensor and actuator harness.
- Faulty contact between terminals in connector.
- Faulty terminal/wire connection.
- Electromagnetic interference (EMI) from an improperly installed 2-way radio, etc., can cause faulty signals to be sent to the ECU.

Storage**Engine Storage Guidelines**

1. Engines can be stored outside for up to three (3) months with no long term preparation IF COVERED BY WATERPROOF COVERING.
2. Engines can be stored in a standard overseas shipping container for up to three (3) months with no long term preparation.
3. Engines can be stored inside, warehoused, for up to six (6) months with no long term preparation.

Engines expected to be stored more than six (6) months, long term storage preparation **MUST** BE taken.

Preparing Engine for Long Term Storage

The following storage preparations are good for long term engine storage up to one year. After that, the engine should be started, warmed up, and retreated for an extended storage period.

IMPORTANT: Any time your engine will not be used for over six (6) months, the following recommendations for storing it and removing it from storage will help to minimize corrosion and deterioration.

1. Change engine oil and replace filter. Used oil will not give adequate protection.
2. Service air cleaner.
3. Draining and flushing of cooling system is not necessary if engine is to be stored only for several months. However, for extended storage periods of a year or longer, it is recommended that the cooling system be drained, flushed, and refilled. Refill with appropriate coolant.
4. Crank the engine several revolutions with starter (do not allow the engine to start).
5. Remove fan/alternator poly-vee belt, if desired.
6. Remove and clean batteries. Store them in a cool, dry place and keep them fully charged.
7. Disengage the clutch for any driveline.

8. Clean the exterior of the engine with salt-free water and touch up any scratched or chipped painted surfaces with a good quality paint.
9. Coat all exposed (machined) metal surfaces with grease or corrosion inhibitor if not feasible to paint.
10. Seal all openings on engine with plastic bags and tape.
11. Store the engine in a dry protected place. If engine must be stored outside, cover it with a waterproof canvas or other suitable protective material and use a strong waterproof tape.

Removing Engine from Long Term Storage

Refer to the appropriate section for detailed services listed below or have your authorized servicing dealer or engine distributor perform services that you may not be familiar with.

1. Remove all protective coverings from engine. Unseal all openings in engine and remove covering from electrical systems.
2. Remove the batteries from storage. Install batteries (fully charged) and connect the terminals.
3. Install fan/alternator poly-vee belt if removed.
4. Fill fuel tank.
5. Perform all appropriate pre-starting checks.

IMPORTANT: DO NOT operate starter more than 30 seconds at a time. Wait at least 2 minutes for starter to cool before trying again.

6. Crank engine for 20nseconds with starter (do not allow the engine to start). Wait 2 minutes and crank engine an additional 20 seconds to assure bearing surfaces are adequately lubricated.
7. Start engine and run at low idle and no load for several minutes. Warm up carefully and check all gauges before placing engine under load.
8. On the first day of operation after storage, check overall engine for leaks and check all gauges for correct operation.

Specifications**General Engine Specifications.**

ITEM	4IRD5AE
Number of Cylinders	4
Bore	106 mm (4.19 in.)
Stroke	127 mm (5.0 in.)
Displacement	4.5 L (276 cu in.)
Compression Ratio	17.0:1
Aspiration	Turbocharged
Engine Firing Order	1-3-4-2
Valves Per Cylinder	1 Intake
	1 Exhaust
Valve Clearance (Cold)	
Intake (Checking)	0.31-0.38 mm (0.012-0.015 in)
Exhaust (Adjusting)	0.36 mm (0.014 in.)
Intake (Checking)	0.31-0.38 mm (0.012-0.015 in)
Exhaust (Checking)	0.41-0.48 mm (0.016-0.019 in)
Intake (Adjusting)	0.36 mm (0.014 in.)
Exhaust (Adjusting)	0.46 mm (0.018 in.)
Max. Crank Pressure	0.5 kPa (2 H ₂ O)
Vibration Damper Maximum Radial Runout	1.50 mm (0.060 in.)
Governor Regulation (Industrial)	7-10%
Thermostat Start To Open	82°C
Temperature	(180°F)
Thermostat Fully Open	94°C
Temperature	(202°F)
Oil Pressure At Rated Speed, Full Load (+15 psi)	345 kPa (50 psi)
Oil Pressure At Low Idle (Minimum)	105 kPa (15 psi)

ITEM	4IRD5AE
Length	860 mm (33.9 in.)
Width	612 mm (24.1 in.)
Height	994 mm (39.1 in.)
Weight	451 kg (993 lb)

Engine Crankcase Oil Fill Quantities

IRD5AE

Crankcase Oil Capacity L (qt) 13.5 (14.3)

Lubrication and Maintenance Records

Using Lubrication and Maintenance Records

Refer to specific Lubrication and Maintenance Section for detailed service procedures.

1. Keep a record of the number of hours you operate your engine by regular observation of hour meter.
2. Check your record regularly to learn when your engine needs service.
3. DO ALL the services within an interval section. Write the number of hours (from your service Records) and the date in the spaces provided. For a complete listing of all items to be performed and the service intervals required, see chart earlier in this manual.

Emission System Warranty

U.S. EPA Emissions Control Warranty Statement

Emissions control-related parts and components are warranted for five years or 3000 hours of operation, whichever occurs first. Further, the engine covered by this warranty was designed, built, and equipped so as to conform at the time of sale with all U.S. emissions standards at the time of manufacture, and that it is free of defects in materials and workmanship which would cause it not to meet these standards within the period of five years or 3000 hours of operation, whichever occurs first.

Warranties stated in this manual refer only to emissions-related parts and components of your engine.

Emissions Control System Certification Label

Statutes providing severe penalties for tampering with emissions controls may apply to the user or dealer.

The emissions warranty applies only to those engines marketed by John Deere that have been certified by the United State Environmental Protection Agency (EPA) and/or California Air Resources Board (CARB); and used in the United States and Canada in non-road mobile (self-propelled or portable/transportable,) equipment. The presence of an emissions labels signifies that the engine has been certified with the EPA and/or CARB.

The EPA and CARB warranties only apply to new engines having the certification label affixed to the engine and sold as stated above in the geographic areas. The presence of an EU number in the third line of the label signifies that the engine has been certified with the European Union countries per Directive 97/68/EC. The emissions warranty does not apply to the EU countries.

NOTE: The hp/kW rating on the engine emissions certification label specifies the gross engine hp/kW, which is flywheel power without fan. In most applications this will not be the same rating as the advertised vehicle hp/kW rating.

*****Always use Ingersoll-Rand Replacement parts!*****



Maintenance



Maintenance

	Initial 500 miles/ 850 km	Daily	Weekly	Monthly	3 Monthly 250 hrs.	6 Monthly 500 hrs.	12 Monthly 1000 hrs.
Compressor Oil Level		C					
Engine Oil Level		C					
*Radiator Coolant Level		C					
Gauges/Lamps		C					
*Air Cleaner Service Indicators		C					
Fuel Tank (Fill at end of day)		C				D	
*Fuel/Water Separator Drain		C					
Oil Leaks		C					
Fuel Leaks		C					
Drain Water From Fuel Filters		D					
Coolant Leaks		C					
Radiator Filler Cap		C					
Air Cleaner Precleaner Dumps			C				
Fan/Alternator Belts			C				
Battery Connections/Electrolyte			C				
Tire Pressure and Surface			C				
*Wheel Lug Nuts				C			
Hoses (Oil, Air, Intake, etc.)				C			
Automatic Shutdown System				C			
Air Cleaner System				C			
Compressor Oil Cooler Exterior				C			
*Engine Rad/Oil Cooler Exterior				C			
Fasteners, Guards					C		
Air Cleaner Elements						R/WI	

*Disregard if not appropriate for this particular machine

(1) or 3000 miles/5000km whichever is the sooner

(2) or as defined by local or national legislation

C = Check (adjust, clean or replace as necessary)

CBT = Check before towing.

CR = Check and report

D = Drain

G = Grease

R = Replace

T = Test

W I = or when indicated if earlier.

Refer to specific sections of the operator's manual for more information

	Initial 500 miles/ 850 km	Daily	Weekly	Monthly	3 Monthly 250 hrs.	6 Monthly 500 hrs	12 Monthly 1000 hrs	18 Monthly 1000 hrs
*Fuel/Water Separator Element						R		
Compressor Oil Filter Element						R		
Compressor Oil						R		
Engine Oil Change						R		
Engine Oil Filter						R		
*Water Pump Grease.							R	
Wheels (Bearings, Seals, etc.)						C		
*Engine Coolant						C	R	
Fuel Filter Element						R		
*Injection Nozzle Check								C
Shutdown Switch Settings							T	
Scavenger Orifice & Related Parts							C	
Oil Separator Element							R	
*Feed Pump Strainer Cleaning.							C	
Coolant Replacement							R	
*Valve Clearance Check							C	
Lights (running, brake, & turn)		CBT						
Pintle Eye Bolts		CBT						
*Brakes	C				C			
*Brake linkage	C							
Emergency stop		T						
Fasteners		C						

Running gear linkage				G				
Safety valve					C			
Running gear bolts (1)					C			

*Disregard if not appropriate for this particular machine

(1) or 3000 miles/5000km whichever is the sooner

(2) or as defined by local or national legislation

C = Check (adjust, clean or replace as necessary)

CBT = Check before towing.

CR = Check and report

D = Drain

G = Grease

R = Replace

T = Test

WI = or when indicated if earlier.

Refer to specific sections of the operator's manual for more information

	Initial 500 miles/ 850 km	Daily	Weekly	Monthly	3 Monthly 250 hrs.	6 Monthly 500 hrs	12 Monthly 1000 hrs
Scavenge line						C	
Pressure system						C	
Engine breather element							C
Pressure gauge							C
Pressure regulator							C
Separator tank (2) exterior							CR
Lubricator (Fill)		C					

	2 Yrs	4 Yrs	6 Yrs				
Safety valve	C						
Hoses		R					
Separator tank (2) interior			C				

*Disregard if not appropriate for this particular machine

(1) or 3000 miles/5000km whichever is the sooner

(2) or as defined by local or national legislation

C = Check (adjust, clean or replace as necessary)

CBT = Check before towing.

CR = Check and report

D = Drain

G = Grease

R = Replace

T = Test

W I = or when indicated if earlier.

Refer to specific sections of the operator's manual for more information

Routine Maintenance

This section refers to the various components which require periodic maintenance and replacement.

The *SERVICE/MAINTENANCE CHART* indicates the various components' descriptions and the intervals when maintenance has to take place. Oil capacities, etc., can be found in the *GENERAL INFORMATION* section of this manual.

For any specification or specific requirement on service or preventative maintenance for the engine, refer to the *Engine Manufacturer's Manual*.

Compressed air can be dangerous if incorrectly handled. Before doing any work on the unit, ensure that all pressure is vented from the system and that the machine cannot be started accidentally.

If the automatic blowdown fails to operate, then pressure must be gradually relieved by operating the manual blowdown valve. Suitable personal protective equipment should be worn.

Ensure that maintenance personnel are adequately trained, competent and have read the Maintenance Manuals.

Prior to attempting any maintenance work, ensure that:-

- all air pressure is fully discharged and isolated from the system. If the automatic blowdown valve is used for this purpose, then allow enough time for it to complete the operation.
- The discharge pipe/manifold area is depressurised by opening the discharge valve, whilst keeping clear of any airflow from it.

MINIMUM PRESSURE VALVE - WHEN FITTED
NOTE: Pressure will always remain in the part of the system between the minimum pressure valve and the discharge valve after operation of the auto blowdown valve.
This pressure must be relieved by carefully.
(a) Disconnecting any downstream equipment.
(b) Opening the discharge valve to atmosphere.
(Use hearing protection if necessary).

- the machine cannot be started accidently or otherwise, by posting warning signs and/ or fitting appropriate anti-start devices.
- all residual electrical power sources (main and battery) are isolated.

Prior to opening or removing panels or covers to work inside a machine, ensure that:-

- anyone entering the machine is aware of the reduced level of protection and the additional hazards, including hot surfaces and intermittently moving parts.
- the machine cannot be started accidentally or otherwise, by posting warning signs and/or fitting appropriate anti-start devices.

Prior to attempting any maintenance work on a *running* machine, ensure that:-

- the work carried out is limited to only those tasks which require the machine to run.
- the work carried out with safety protection devices disabled or removed is limited to only those tasks which require the machine to be running with safety protection devices disabled or removed.
- all hazards present are known (e.g. pressurised components, electrically live components, removed panels, covers and guards, extreme temperatures, inflow and outflow of air, intermittently moving parts, safety valve discharge etc.).
- appropriate personal protective equipment is worn.
- loose clothing, jewellery, long hair etc. is made safe.
- warning signs indicating that *Maintenance Work is in Progress* are posted in a position that can be clearly seen.

Upon completion of maintenance tasks and prior to returning the machine into service, ensure that:-

- the machine is suitably tested.
- all guards and safety protection devices are refitted.
- all panels are replaced, canopy and doors closed.
- hazardous materials are effectively contained and disposed of.

Productive Shutdown System

Refer to the Wedge diagnostic display codes table for a listing of shutdown conditions.

Low engine fuel level switch.

At three month intervals, test the low engine fuel level switch circuit as follows:

- Start the machine.

NOTE: Do not press the load button.

- Disconnect the switch, the machine should shutdown.
- Re-connect the switch.

At twelve month intervals, test the low engine fuel level switch by removing and operating the float manually.



Never remove or replace switches when the machine is running.

Scavenge Line

The scavenge line runs from the combined orifice/drop tube in the separator tank, to the orifice fitting located in the airend.

Examine the orifice, check valve and hoses at every service or in the event of oil carryover into the discharge air.

It is good preventative maintenance to check that the scavenge line and tube are clear of any obstruction each time the compressor lubricant is changed as any blockage will result in oil carryover into the discharge air.

Compressor Oil Filter

Refer to the *MAINTENANCE CHART* in this section for the recommended servicing intervals.

Removal

WARNING

Do not remove the filter(s) without first making sure that the machine is stopped and the system has been completely relieved of all air pressure. (Refer to *STOPPING THE UNIT* in the *OPERATING INSTRUCTIONS* section of this manual).

Clean the exterior of the filter housing and remove the spin-on element by turning it in a counter-clockwise direction.

Inspection

Examine the filter element.

CAUTION

If there is any indication of the formation of varnishes, shellacs or lacquers on the filter element, it is a warning that the compressor lubricating and cooling oil has deteriorated and that it should be changed immediately. Refer to *LUBRICATION* later in this section.

Reassembly

Clean the filter gasket contact area and install the new element by screwing in a clockwise direction until the gasket makes contact with the filter housing. Tighten a further $\frac{1}{2}$ to $\frac{3}{4}$ of a revolution.

CAUTION

Start the machine (refer to *PRIOR TO STARTING* and *STARTING THE UNIT* in the *OPERATING INSTRUCTIONS* section of this manual) and check for leakage before the machine is put back into service.

Compressor Oil Separator Element

Normally the separator element will not require periodic maintenance provided that the air and oil filter elements are correctly maintained.

If, however, the element has to be replaced, then proceed as follows:

Removal

WARNING

Do not remove the filter(s) without first making sure that the machine is stopped and the system has been completely relieved of all air pressure. (Refer to *STOPPING THE UNIT in the OPERATING INSTRUCTIONS* section of this manual).

Disconnect all hoses and tubes from the separator tank cover plate. Remove the drop-tube from the separator tank cover plate and then remove the cover plate. Remove the separator element.

Inspection

Examine the filter element. Examine all hoses and tubes, and replace if necessary.

Reassembly

Thoroughly clean the orifice/drop tube and filter gasket contact area before reassembly. Install the new element.

WARNING

Do not remove the staple from the anti-static gasket on the separator element since it serves to ground any possible static build-up. Do not use gasket sealant since this will affect electrical conductance.

Reposition the cover plate, taking care not to damage the gasket, and replace the cover plate screws tightening in a *criss-cross* pattern to the recommended torque (refer to the *TORQUE SETTING TABLE* later in this section).

Engage the adaptor in the cover plate with the drop-tube integral with the filter, reconnect all hoses and tubes to the separator tank cover plate.

Replace the compressor oil (refer to *LUBRICATION* later in this section).

 **CAUTION**

Start the machine (*refer to PRIOR TO STARTING and STARTING THE UNIT in the OPERATING INSTRUCTIONS section of this manual*) and check for leakage before the machine is put back into service.

Compressor Oil Cooler and Engine Radiator

When grease, oil and dirt accumulate on the exterior surfaces of the oil cooler and radiator, the efficiency is impaired. It is recommended that each month the oil cooler and radiator be cleaned by directing a jet of compressed air, (carrying if possible a non-flammable cleaning solvent) over the exterior core of the cooler/radiator. This should remove any accumulation of oil, grease and dirt from the exterior core of the cooler so that the entire cooling area can radiate the heat of the lubricating and cooling oil/water into the air stream.

 **WARNING**

Hot engine coolant and steam can cause injury. When adding coolant or antifreeze solution to the engine radiator, stop the engine at least one minute prior to releasing the radiator filler cap. Using a cloth to protect the hand, slowly release the filler cap, absorbing any released fluid with the cloth. Do not remove the filler cap until all excess fluid is released and the engine cooling system fully depressurised.

 **WARNING**

Follow the instructions provided by the antifreeze supplier when adding or draining the antifreeze solution. It is advisable to wear personal protective equipment to prevent skin and eye contact with the antifreeze solution.

Air Filter Elements

The air filter should be inspected regularly (*refer to the SERVICE/MAINTENANCE CHART*) and the element replaced when the restriction indicator shows red or every 6 Months (500 hours), whichever comes first. The dust collector box(es) should be cleaned daily (more frequently in dusty operating conditions) and not allowed to become more than half full.

Removal



Never remove and replace element(s) when the machine is running.

Clean the exterior of the filter housing and remove the filter element by releasing the nut.

Inspection

Check for cracks, holes or any other damage to the element by holding it up to a light source, or by passing a lamp inside.

Check the seal at the end of the element and replace if any sign of damage is evident.

Reassembly

Assemble the new element into the filter housing ensuring that the seal seats properly.

Reset the restriction indicator by depressing the rubber diaphragm.

Assemble the dust collector box parts, ensuring that they are correctly positioned.

Before restarting the machine, check that all clamps are tight.

Ventilation

Always check that the air inlets and outlets are clear of debris etc.



NEVER clean by blowing air inwards.

Cooling Fan Drive

Periodically check that the fan mounting bolts in the fan hub have not loosened. If, for any reason, it becomes necessary to remove the fan or re-tighten the fan mounting bolts, apply a good grade of commercially available thread locking compound to the bolt threads and tighten to the torque value shown in the *TORQUE SETTING TABLE* later in this section.

The fan belt(s) should be checked regularly for wear and correct tensioning.

Fuel System

The fuel tank should be filled daily or every eight hours. To minimize condensation in the fuel tank(s), it is advisable to top up after the machine is shut down or at the end of each working day. At six month intervals drain any sediment or condensate that may have accumulated in the tank(s).

Fuel Filter Water Separator

The fuel filter water separator contains a filter element which should be replaced at regular intervals (see the *SERVICE/MAINTENANCE CHART*).

Charge Air Cooler Pipework

Inspect all hoses and clips on the charge cooler pipe work.

Engine damage will occur if the charge cooling system leaks.

Hoses

All components of the engine cooling air intake system should be checked periodically to keep the engine at peak efficiency.

At the recommended intervals, (see the *SERVICE/MAINTENANCE CHART*), inspect all of the intake lines to the air filter, and all flexible hoses used for air lines, oil lines and fuel lines.

Periodically inspect all pipe work for cracks, leaks, etc. and replace immediately if damaged.

Electrical System



Always disconnect the battery cables before performing any maintenance or service.

Inspect the safety shutdown system switches and the instrument panel relay contacts for evidence of arcing and pitting. Clean where necessary.

Check the mechanical action of the components.

Check the security of electrical terminals on the switches and relays i.e. nuts or screws loose, which may cause local hot spot oxidation.

Inspect the components and wiring for signs of overheating i.e. discolouration, charring of cables, deformation of parts, acrid smells and blistered paint.

Battery

Keep the battery terminals and cable clamps clean and lightly coated with petroleum jelly to prevent corrosion.

The retaining clamp should be kept tight enough to prevent the battery from moving.

Pressure System

At 500 hour intervals it is necessary to inspect the external surfaces of the system (from the air end through to the discharge valve(s)) including hoses, tubes, tube fittings and the separator tank, for visible signs of impact damage, excessive corrosion, abrasion, tightness and chafing. Any suspect parts should be replaced before the machine is put back into service.

Tyres/Tyre/Tire Pressure

See the *GENERAL INFORMATION* section of this manual.

Running Gear/Wheels

Check the wheel nut torque 20 miles (30 kilometres) after refitting the wheels. Refer to the *TORQUE SETTING TABLE* later in this section.

Lifting jacks should only be used under the axle.

The bolts securing the running gear to the chassis should be checked periodically for tightness (refer to the *SERVICE/MAINTENANCE CHART* for frequency) and re-tightened where necessary. Refer to the *TORQUE SETTING TABLE* later in this section.

CAUTION

Check the wheel nut torque 20 miles (30 kilometres) after refitting the wheels (Refer to the TORQUE SETTING TABLE later in this section).

Lubrication

The engine is initially supplied with engine oil sufficient for a nominal period of operation (for more information, consult the Engine section of this manual).

CAUTION

Always check the oil levels before a new machine is put into service.

If, for any reason, the unit has been drained, it must be re-filled with new oil before it is put into operation.

Engine Lubricating Oil

The engine oil should be changed at the engine manufacturer's recommended intervals. Refer to the Engine section of this manual.

Engine Lubricating Oil Specification

Refer to the Engine section of this manual.

Engine Oil Filter Element

The engine oil filter element should be changed at the engine manufacturer's recommended intervals. Refer to the Engine section of this manual.

Compressor Lubricating Oil

Refer to the *SERVICE/MAINTENANCE CHART* in this section for service intervals.

NOTE: If the machine has been operating under adverse conditions, or has suffered long shutdown periods, then more frequent service intervals will be required.

WARNING

DO NOT, under any circumstances, remove any drain plugs or the oil filler plug from the compressor lubricating and cooling system without first making sure that the machine is stopped and the system has been completely relieved of all air pressure (refer to *STOPPING THE UNIT* in the *OPERATING INSTRUCTIONS* section of this manual).

Completely drain the receiver/separator system including the piping and oil cooler by removing the drain plug(s) and collecting the used oil in a suitable container.

Replace the drain plug(s) ensuring that each one is secure.

NOTE: If the oil is drained immediately after the machine has been running, then most of the sediment will be in suspension and will therefore drain more readily.

**CAUTION**

Some oil mixtures are incompatible and result in the formation of varnishes, shellacs or lacquers which may be insoluble.

NOTE: Always specify INGERSOLL-RAND Pro-Tec™ oil for use at all ambient temperatures above -23°C.

Compressor Oil Filter Element

Refer to the *SERVICE/MAINTENANCE CHART* in this section for service intervals.

Running Gear Wheel Bearings

Wheel bearings should be packed with grease every 6 months. The type of grease used should conform to specification *MIL-G-10924*.

Speed and Pressure Regulation Adjustment

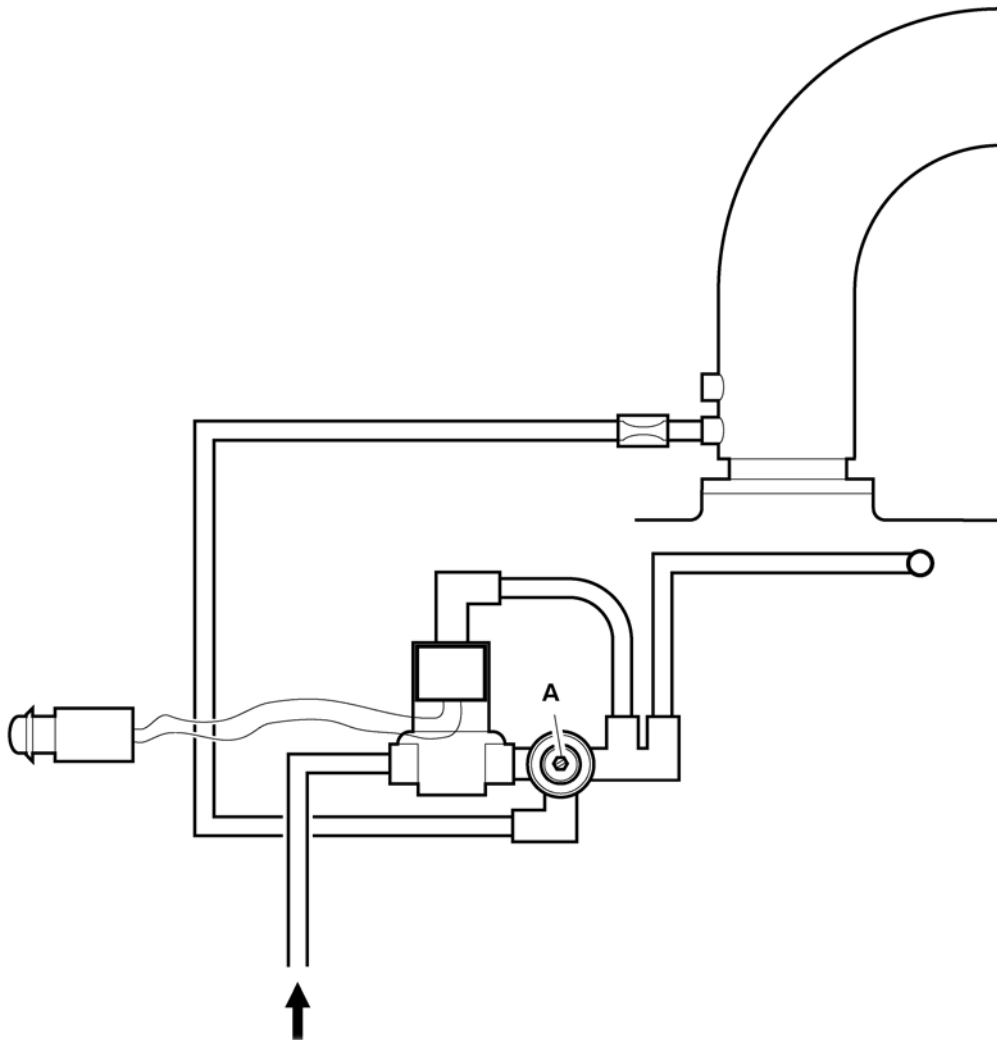

Normally, regulation requires no adjusting, but if correct adjustment is lost, proceed as follows:
Refer to the diagram above.

A. Adjusting screw

Start the machine (Refer to *STARTING INSTRUCTIONS* in the *OPERATING INSTRUCTIONS* section of this manual).

Adjust the service valve on the outside of the machine to maintain rated pressure at full speed. If full speed is not maintained at rated pressure, then turn the adjusting screw clockwise to increase the pressure. Optimum adjustment is achieved when full speed is achieved at rated pressure.

Close the service valve. The engine will slow to idle speed.

TABLE 1		INCH FASTENERS			
		NOMINAL DESIGN TORQUE			
CAPSCREW OR NUT THREAD SIZE AND PITCH	8AE J249 GRADE 5 (HEAD MARKING)		8AE J249 GRADE 8 (HEAD MARKING)		
	(Nm.)	(FT-LBF)	(Nm.)	(FT-LBF)	
1/4 - 20	11	8	16	12	
5/16 - 18	24	17	33	25	
3/8 - 16	42	31	59	44	
7/16 - 14	67	49	95	70	
1/2 - 13	102	75	144	106	
9/16 - 12	148	109	208	154	
5/8 - 11	203	150	287	212	
3/4 - 10	361	266	509	376	



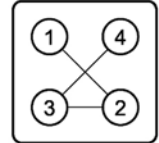

TYPICAL RECTANGULAR TORQUE PATTERN

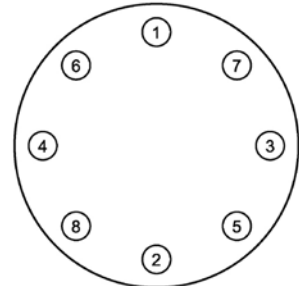

TYPICAL SQUARE TORQUE PATTERN



TYPICAL CIRCULAR TORQUE PATTERN

TABLE 2 METRIC FASTENERS						
CAPSCREW OR NUT THREAD SIZE AND PITCH	NOMINAL DESIGN TORQUE					
	PROPERTY GRADE 8.8 (HEAD MARKING)		PROPERTY GRADE 10.9 (HEAD MARKING)		PROPERTY GRADE 12.9 (HEAD MARKING)	
						
	(Nm.)	(FT-LBF)	(Nm.)	(FT-LBF)	(Nm.)	(FT-LBF)
M6 X 1.0	11	8	15	11	18	13
M8 X 1.25	26	19	36	27	43	31
M10 X 1.5	52	38	72	53	84	62
M12 X 1.75	91	67	126	93	147	109
M14 X 2	145	107	200	148	234	173
M16 X 2	226	166	313	231	365	270
M20 X 2.5	441	325	610	450	713	526



TYPICAL RECTANGULAR TORQUE PATTERN

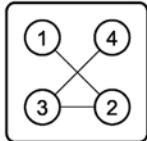

TYPICAL SQUARE TORQUE PATTERN

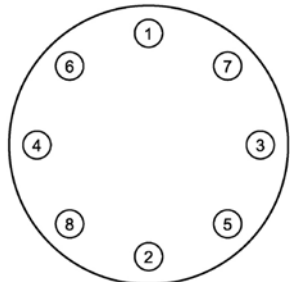

TYPICAL CIRCULAR TORQUE PATTERN

Compressor Lubrication Chart

Refer to these charts for correct compressor fluid required. Note that the selection of fluid is dependent on the design operating pressure of the machine and the ambient temperature expected to be encountered before the next oil change.

NOTE: Fluids listed as "preferred" are required for extended warranty.

Compressor oil carryover (oil consumption) may be greater with the use of alternative fluids.

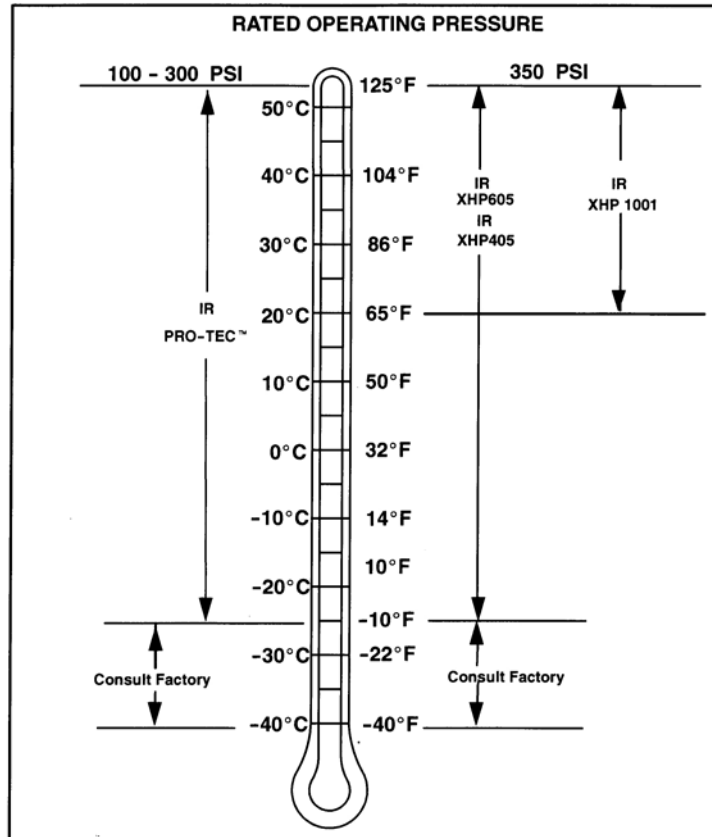

Preferred Ingersoll-Rand Fluids - Use of these fluids with original I-R filters can extend aircend warranty. Refer to operator's manual warranty section for details or contact your I-R representative.

Design Operating Pressure	Ambient Temperature	Specification
100 psi to 300 psi	-10°F to 125°F (-23°C to 52°C)	Preferred: IR Pro-Tec™ Alternate: ISO Viscosity Grade 46 with rust and oxidation inhibitors, designed for air compressor service.
350 psi	(-23°C to 52°C) -10°F to 125°F 65°F to 125°F (-18°C to 52°C)	Preferred: IR XHP 605 Alternate: IR XHP 405 ISO Viscosity Grade 68 Group 3 or 5 with rust and oxidation inhibitors designed for air compressor service. Preferred: XHP605 IR XHP 1001

Ingersoll-Rand Preferred Fluids	1 gal. (3.8 Litre)	5 gal. (19.0 Litre)	55 gal. (208.2 Litre)	220 gal. (836 litre)
Preferred:				
IR Pro-Tec™	36899698	36899706	36899714	36899722
IR XHP605	---	22252076	22252050	22252068
IR XHP 1001	---	35612738	35300516	---
XHP405	---	22252126	22252100	22252118
Engine Oil	54480918	36875938	36866903	

Machine Systems



Machine Systems

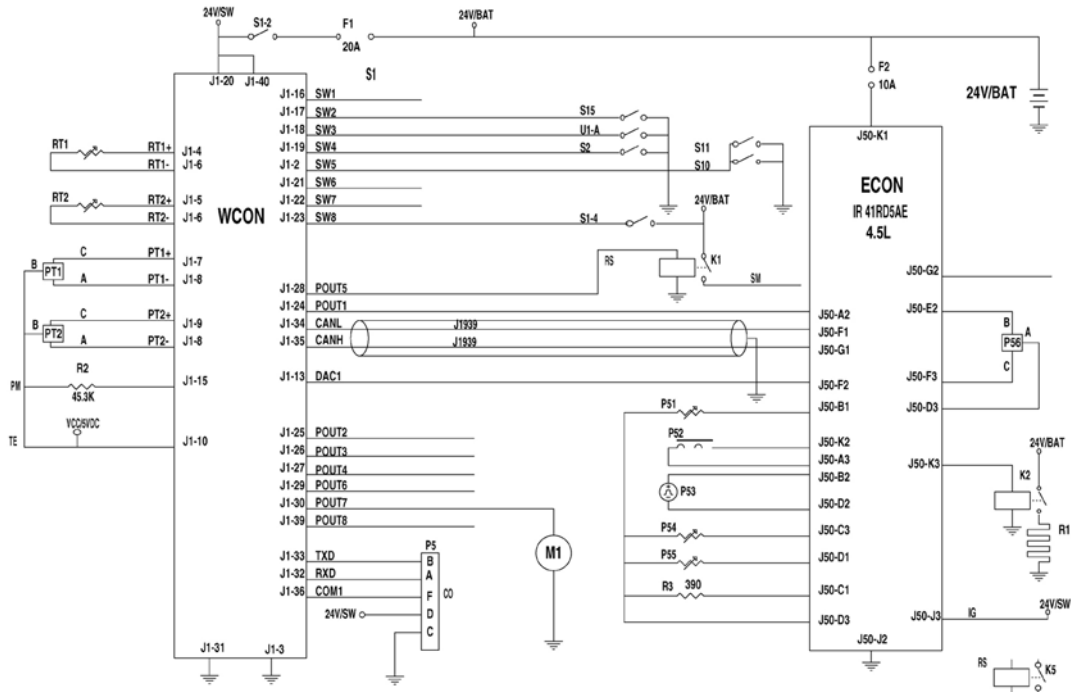

Key

BAT	Battery	PT1	Pressure transducer, separator tank 0-500 PSIG
CO	RS232C comms	PT2	Pressure transducer, regulation system 0-100 PSIG
ECON	Engine controller	PM	Plug, machine ID
IG	Isochronous governor	R3	Idle sel
J50-G2	Wait to start lamp	RS	Relay-spst
J50-K3	Inlet heater	RT1	Thermistor, separator tank temperature -30- 255 ⁰ F
P51	Coolant temp	RT2	Thermistor, airend discharge temperature -30- 255 ⁰ F
P52	Inject	SI	Switch inputs
P53	Crank sensor	SM	Starter motor
P54	Fuel temp	SW1	Spare
P55	Manifold air temp	SW2	Display scroll
P56	Oil pressure	SW3	Low fuel shutdown
POUT1	Engine key switch	SW4	Switch, service air
POUT2	Solenoid, start/run		

POUT3	Comp fault lamp	SW5	Air filter rest (option)
POUT4	Engine fault lamp	SW6	Spare
POUT5	Start relay	SW7	Spare
POUT6	Spare	SW8	Switch, start
POUT7	Hour meter	TE	Transducer excitation
POUT8	Spare	WCON	Wedge controller

Wedge to Engine Interface - IR Engine

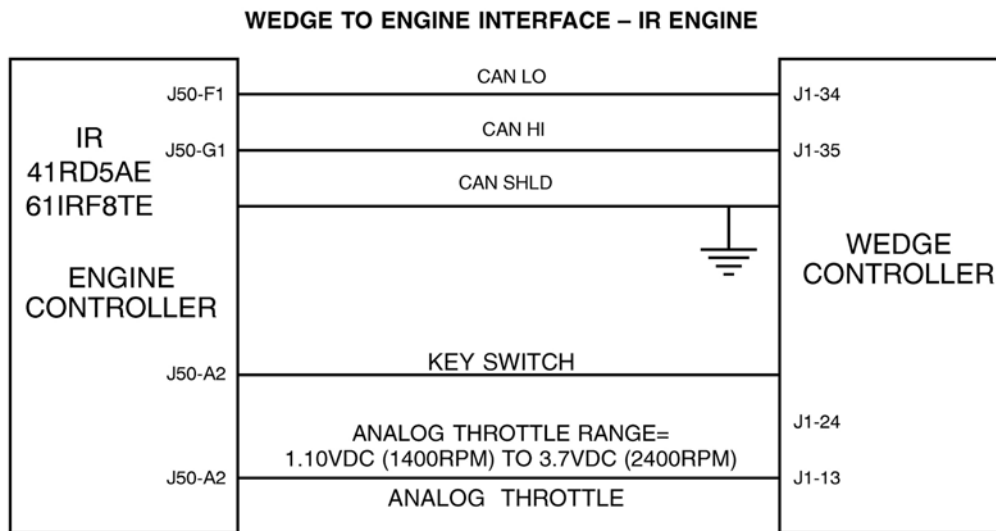

Harness System Schematic

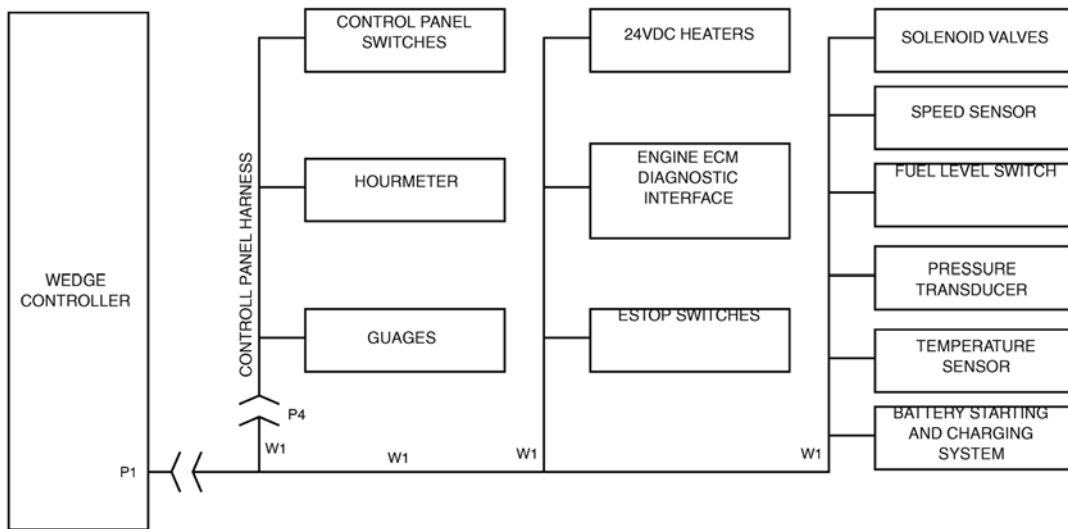

J1939 CAN Communications Schematic

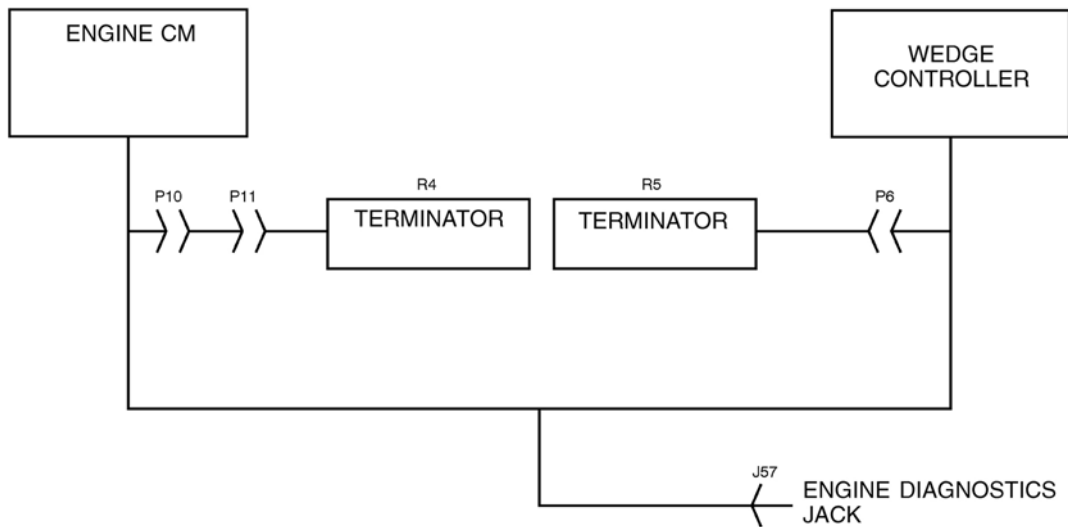

Service Tools



Service Tools



Electronic Systems



The following special tools are recommended to perform service procedures in this manual. The tools can be purchased from Ingersoll-Rand or equivalent substitutes can be used.

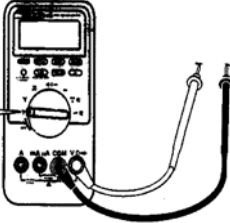

Tool	Tool Description
Fluke 87	Digital Multimeter <i>Used to measure electrical circuits: volts, ohms amps</i>
54729660	Weather-Pack Terminal Removal Tool <i>Used to repair Packard Electric Weather-Pack Connectors.</i>
54729678	Deutsch Terminal Removal Tool (Blue) <i>Used to repair Deutsch connectors</i>
54729686	Deutsch Terminal Removal Tool (Red) <i>Used to repair Deutsch connectors</i>
54729694	Deutsch Terminal Removal Tool (Yellow) <i>Used to repair Deutsch connectors</i>
HDT-48-00	Deutsch Terminal Crimp Tool <i>Used to crimp Deutsch connector terminals</i>
DD	Deutsch Terminal Crimping Tool <i>Used to crimp Deutsch connector terminals</i>
54729710	Electrical Contact Cleaner <i>Used to clean electrical contacts and connectors</i>
54729728	PDA Service Tool <i>Palm Pilot based service tool used to connect to Intellisys (SGP) Controller to load software and extract service information</i>
22073886	Packard Crimp Tool <i>Used to crimp Packard connector terminals</i>

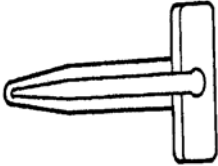
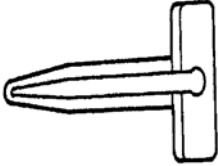
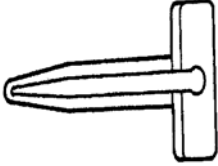
Tool	Tool Description
22073878	Thermistor Simulator Plug <i>Used to test thermistor circuits</i>
54699616	Deutsch Terminal Removal Tool <i>Used to repair Deutsch connectors</i>
54699657	Deutsch Terminal Removal Tool <i>Used to repair Deutsch connectors</i>
54749643	Packard Metri-Pack Terminal Removal Tool <i>Used to repair Metri-Pack connectors</i>
54749635	Connector Repair Kit <i>Used to make connector repairs</i>

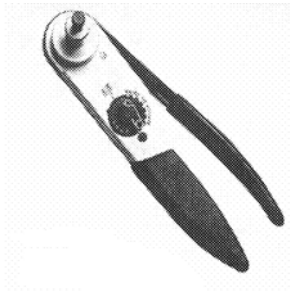
Service Tools

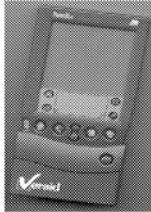
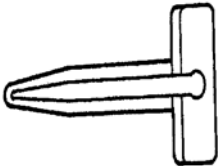
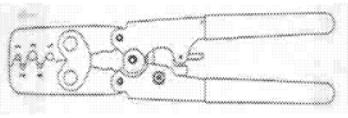
Tool No	Tool Description	Tool Illustration
<p>Fluke 87</p>	<p>Digital multimeter Available from electrical and electronic parts distributors</p>	
<p>54729660</p>	<p>Weather-Pack Terminal Removal Tool</p>	
<p>54699632</p>	<p>Deutsch Terminal Removal Tool (Blue)</p>	
<p>54699640</p>	<p>Deutsch Terminal Removal Tool (Red)</p>	
<p>54699624</p>	<p>Deutsch Terminal Removal Tool (Yellow)</p>	

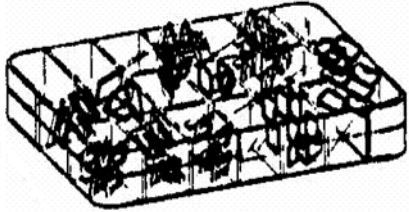
<p>DT-RT1</p>	<p>Crimp Tool for deuth pins Crimp Available from: Ladd Industries (800-223-1236)</p>	
<p>54729710</p>	<p>Electrical Contact Cleaner</p>	
<p>54729728</p>	<p>PDA Service Tool</p>	
<p>54699616</p>	<p>Deutsch Terminal Removal Tool</p>	
<p>22073886</p>	<p>Packard Crimp Tool</p>	
<p>22073878</p>	<p>Thermistor Simulator</p>	

<p>54749635</p>	<p>Connector Repair Kit</p>	
<p>54699657</p>	<p>Deutsch Terminal Removal Tool</p>	
<p>54749643</p>	<p>Packard Metri-Pack Removal Tool</p>	

Electrical Parts

PARTS NUMBERS	DESCRIPTION	QTY PER MACHINE	PARTS NUMBERS	DESCRIPTION	QTY PER MACHINE
36920825	0-100 psi PRESSURE TRANSDUSER	1	54731427	FUEL LEVEL SENDER	1
54765946	0-500 psi PRESSURE TRANSDUSER	1	22173579	WEDGE CONTROLLER	1
36898922	THERMISTOR PROBE	2	22199061	W1 CHASSIS HARNESS	1
36840841	SOELNOID VALVE	1*	22179659	W1 CHASSIS HARNESS DIAGRAM	N/A
36853521	STARTER AND INLET HEATER RELAY	2	36792083	FUSE 20 AMP BLADE	1
35610856	NEGATIVE BATTERY CABLE	1	22071591	FUSE 10 AMP BLADE	1
35583582	POSITIVE BATTERY CABLE	1	54475777	DIAGNOSTIC SWITCH	1
35578194	ENGINE GROUND STRAP	1	22201354	MACHINE ID PLUG	1

* Quantity two (2) per machine on P600WIR (7/170) model only

Fault Finding



Fault Finding

FAULT	CAUSE	REMEDY
<p>No reaction from instrument panel when key turned to (I) position.</p>	<p><i>Emergency stop actuated.</i></p> <p><i>Batteries not connected.</i></p> <p><i>Fuse at starter motor 'blown'.</i></p>	<p>Reset emergency stop button.</p> <p>Connect batteries.</p> <p>Replace fuse.</p>
<p>Engine fails to start.</p>	<p><i>Low battery charge.</i></p> <p><i>Bad earth connection.</i></p> <p><i>Loose connection.</i></p> <p><i>Fuel starvation.</i></p> <p><i>Relay failed.</i></p> <p><i>Faulty stop solenoid</i></p>	<p>Check the fan belt tension, battery and cable connections.</p> <p>Check the earth cables, clean as required.</p> <p>Locate and make the connection good.</p> <p>Check the fuel level and fuel system components. Replace the fuel filter if necessary.</p> <p>Replace the relay.</p> <p>Check the stop solenoid</p>
<p>Engine stops while in service or is reluctant to start.</p>	<p><i>Low fuel level.</i></p> <p><i>Safety shut-down system in operation.</i></p>	<p>Fill fuel tank and bleed air from fuel system if necessary. (Refer to <i>MAINTENANCE SECTION</i>).</p> <p>Check the safety shut-down switches.</p>
<p>Engine starts but stalls when the switch returns to position I</p>	<p><i>Electrical fault</i></p> <p><i>Low engine oil pressure.</i></p> <p><i>Low water level</i></p> <p><i>Faulty relay</i></p> <p><i>Faulty key-switch</i></p>	<p>Test the electrical circuits.</p> <p>Check the oil level and the oil filter(s).</p> <p>Check if the low water lamp is extinguished.</p> <p>Check the relays.</p> <p>Check the key-switch.</p>

FAULT	CAUSE	REMEDY
<p>Engine starts but will not run or engine shuts down prematurely.</p>	<p><i>Electrical fault.</i></p> <p><i>Low engine oil pressure.</i></p> <p><i>Safety shut-down system in operation.</i></p> <p><i>Fuel starvation.</i></p> <p><i>Switch failure.</i></p> <p><i>High compressor oil temperature.</i></p> <p><i>Water present in fuel system.</i></p> <p><i>Faulty relay.</i></p>	<p>Test the electrical circuits.</p> <p>Check the oil level and oil filter(s).</p> <p>Check the safety shut-down switches.</p> <p>Check the fuel level and fuel system components. Replace the fuel filter if necessary.</p> <p>Test the switches.</p> <p>Check the compressor oil level and oil cooler. Check the fan drive.</p> <p>Check the water separator and clean if required.</p> <p>Check the relay in the holder and replace if necessary.</p>
<p>Engine Overheats.</p>	<p><i>Low water level</i></p> <p><i>Blocked radiator.</i></p> <p><i>Reduced cooling air from fan.</i></p> <p><i>Faulty thermostat</i></p>	<p>Check the level and replenish if necessary.</p> <p>Stop the machine and clean the cooling fins with compressed air or steam. Use reduced pressure for cleaning the fins.</p> <p>Check the fan and the drive belts. Check for any obstruction inside the cowl.</p> <p>Check the thermostat and replace if necessary.</p>
<p>Engine speed too high</p>	<p><i>Incorrect throttle arm setting.</i></p>	<p>Check the engine speed setting.</p>
<p>Engine speed too low.</p>	<p><i>Incorrect throttle arm setting.</i></p> <p><i>Blocked fuel filter.</i></p> <p><i>Faulty regulator valve.</i></p> <p><i>Incorrectly set regulation system</i></p> <p><i>Premature unloading.</i></p>	<p>Check the engine speed setting.</p> <p>Check and replace if necessary.</p> <p>Check the regulation system.</p> <p>Reset the regulation system. Refer to <i>SPEED AND PRESSURE REGULATION ADJUSTMENT</i> in the <i>MAINTENANCE</i> section of this manual.</p> <p>Check the regulation and the operation of the air cylinder.</p>

FAULT	CAUSE	REMEDY
Excessive vibration.	<i>Engine speed too low.</i>	See "Engine speed too low"
Leaking oil seal.	<i>Improperly fitted oil seal.</i>	Replace the oil seal.
Refer also to the <i>Engine Manufacturer's Manual</i>.		
Air discharge capacity too low.	<i>Engine speed too low.</i> <i>Blocked air cleaner.</i> <i>High pressure air escaping.</i> <i>Incorrectly set regulation system.</i>	Check the air cylinder and air filter(s). Check the restriction indicators and replace the element(s) if necessary. Check for leaks. Reset the regulation system. Refer to SPEED AND PRESSURE REGULATION ADJUSTMENT in the MAINTENANCE section of this manual.
Compressor overheats.	<i>Low oil level.</i> <i>Dirty or blocked oil cooler.</i> <i>Incorrect grade of oil.</i> <i>Defective by-pass valve.</i> <i>Recirculation of cooling air.</i> <i>Reduced cooling air from fan.</i>	Top up the oil level and check for leaks. Clean the oil cooler fins. Use Ingersoll-Rand recommended oil. Check the operation of the element and replace if necessary. Move the machine to avoid recirculation. Check the fan and the drive belts. Check for any obstruction inside the fan cowl.
Excessive oil present in the discharge air.	<i>Blocked scavenge line.</i> <i>Perforated separator element.</i> <i>Pressure in the system is too low.</i>	Check the scavenge line, drop tube and orifice. Clean and replace. Replace the separator element. Check the minimum pressure valve.
Safety valve operates.	<i>Operating pressure too high.</i> <i>Incorrect setting of the regulator.</i> <i>Faulty regulator.</i>	Check the setting and operation of the regulator valve piping. Adjust the regulator. Replace the regulator.

FAULT	CAUSE	REMEDY
	<i>Inlet valve set incorrectly.</i>	Refer to <i>SPEED AND PRESSURE REGULATION ADJUSTMENT</i> in the <i>MAINTENANCE</i> section of this manual.
	<i>Loose pipe/hose connections.</i>	Check all pipe/hose connections.
	<i>Faulty safety valve.</i>	Check the relieving pressure. Replace the safety valve if faulty. DO NOT ATTEMPT A REPAIR.
Oil is forced back into the air filter.	<i>Incorrect stopping procedure used</i>	Always employ the correct stopping procedure. Close the discharge valve and allow the machine to run on idle before stopping.
	<i>Faulty inlet valve.</i>	Check for free operation of the inlet valve(s).
Machine goes to full pressure when started.	<i>Faulty load valve.</i>	Replace the valve.
Machine fails to load when the load button is pressed.	<i>Faulty load valve.</i>	Replace the valve.
	<i>Faulty switch.</i>	Test switch.
	<i>Loose pipe/hose connections.</i>	Check all pipe/hose connections.

*****Always use Ingersoll-Rand Replacement parts!*****



Options



Options - Lubricator

(For units manufactured in North America)

Safety

WARNING

Ensure that the lubricator filler cap is re-tightened correctly after replenishing with oil.

WARNING

Do not replenish the lubricator oil, or service the lubricator without first making sure that the machine is stopped and the system has been completely relieved of all air pressure (Refer to *STOPPING THE UNIT* in the *OPERATING INSTRUCTIONS* section of this manual).

CAUTION

If the nylon tubes to the lubricator are disconnected then ensure that each tube is re-connected in its original location.

General Information

Oil capacity:

1 QT Option-0.95 Litre (1qt)

2 QT Option-1.9 Litre (2qts)

Oil specification:

Refer to the *Tool Manufacturer's Manual*.

Operating Instructions

Commissioning

Check the lubricator oil level and fill as necessary.

Prior to Starting

Check the lubricator oil level and replenish as necessary.

Maintenance

Check the lubricator oil level and replenish as necessary.

Fault Finding

FAULT	CAUSE	REMEDY
No oil flow.	<i>Incorrect connection</i>	Reverse the nylon tube connections to the lubricator.

*****Always use Ingersoll-Rand Replacement parts!*****



